

PW3335

HIOKI

PW3335-01, PW3335-02

PW3335-03, PW3335-04

Instruction Manual

POWER METER



Be sure to read this manual before using the instrument.

Safety Information ► p.3



When using the instrument for the first time

Names and Functions of Parts ► p.13

Measurement Preparations ► p.25



Troubleshooting

Troubleshooting ► p.168

Error Indication ► p.170

EN

Mar. 2019 Revised edition 3

PW3335A981-03 19-03H



Contents

Introduction.....	1
Confirming Package Contents.....	2
Safety Information	3
Operating Precautions.....	5

Chapter 1 Overview 11

1.1 Product Overview	11
1.2 Features	11
1.3 Names and Functions of Parts	13
1.4 Measurement Workflow	20

Chapter 2 Measurement Preparations 25

2.1 Installation and Connection Procedures	25
2.2 Connecting the Measurement Lines ..26	
■ Connecting the measurement lines	27
2.3 Connecting the Power Cord	33
2.4 Turning On the Instrument	34
2.5 Performing Zero-adjustment	35
2.6 Activating Power to the Measurement Lines	36
2.7 Turning Off the Instrument	36

Chapter 3 Configuration and Measurement 37

3.1 Pre-Measurement Inspection	37
3.2 Configuring Settings	38
3.2.1 Selecting the Current Input Method	38
3.2.2 Selecting Display Content	40
■ Selecting display parameters	40
■ Selecting the rectifier	42
3.2.3 Selecting the Voltage and Current Ranges	43
■ Selecting the desired range	43

■ Automatically setting the range (auto-range operation)	44
■ Skipping unnecessary ranges (range select function)	46
3.2.4 Setting the Synchronization Source (SYNC)	48
3.2.5 Setting the Frequency Measurement Range(Zero-cross filter).....	50
■ Significance of changing the zero-cross threshold level	52
■ Setting the zero-cross filter's threshold level	53
3.2.6 Setting the Timeout	54
3.2.7 Displaying Measured Values as an Average (AVG: Averaging)	56
3.2.8 Setting the VT Ratio and CT Ratio ..58	
■ Setting the VT ratio	59
■ Setting the CT ratio	60
3.3 Integration	61
■ Starting integration	64
■ Stopping integration	64
■ Starting integration while adding to previous integrated values (additional integration).....	64
■ Canceling integration (resetting integrated values) (DATA RESET)	65
■ Performing integration after setting an integration time (timer integration)	65
■ Enabling auto-range integration	67
■ Starting and stopping auto-range integration	68
■ Integration precautions	69
3.3.1 Integrated Value Display Format	70
3.4 Viewing Harmonic Measured Values ..71	
3.4.1 Setting the Synchronization Source ..	71
3.4.2 Method for Displaying Harmonic Measurement Parameters	71
3.4.3 Setting the Harmonic Analysis Order Upper Limit	76
3.4.4 About the HRM ERROR lamp	77
3.5 Performing Synchronized Measurement with Multiple Instruments (Multiple-instrument Synchronized Measurement).....	78
■ Connecting 2 instruments (PW3335) with a synchronization cable	79
■ Configuring synchronized measurement ..	80

Contents

3.6	External Control	82
■	External control terminal (EXT.CONTROL)	82
■	Connecting wires to the external control terminals	84
3.7	Using D/A Output	85
■	Connecting wires to D/A output terminals ..	87
3.7.1	Level Output, High-speed Level Output, and Waveform Output	88
■	Setting the output parameter, rectifier, and output method for D/A output channels	89
■	Setting D/A output when enabling auto-range integration	91
■	Example uses	94
■	Output voltage of level output	95
■	Output voltage of waveform output	99
3.8	Using a Current Sensor	100
■	Before connecting a current sensor	101
■	Connecting a TYPE.1 current sensor	102
■	Connecting a TYPE.2 current sensor	102
■	Setting external current sensor input	104
■	Using an external CT	105
3.9	Other Functions	106
3.9.1	Fixing Display Values (Display Hold)	106
■	Activating display hold	106
■	Canceling the display hold state	106
3.9.2	Displaying Maximum, and Minimum Values (MAX/MIN)	107
■	Switching the display among the maximum, minimum, and instantaneous values	107
■	Clearing maximum and minimum values ..	108
3.9.3	Disabling Control Keys (Key Lock) ..	109
■	Enabling the key lock state	109
■	Canceling the key lock state	109
3.9.4	Initializing the Instrument (System Reset)	110
■	Factory Settings	111
3.10	When warning lamp, o.r, or the Unit Indicator Flashes	112
3.10.1	If the PEAK OVER U or PEAK OVER I Lamp Lights Up	112
3.10.2	If the CURRENT • Lamp Flashes ..	112
3.10.3	When o.r (over-range) Is Displayed ..	113
3.10.4	When the Unit Indicator Flashes ...	114
3.11	Connecting the Instrument to Hioki LR8410 Link compatible Logger ..	115

Chapter 4 Connection to a PC 119

4.1	Configuring and Connecting the Instrument	120
4.1.1	Using the LAN Interface	120
■	Setting the LAN's IP address	121
■	Setting the LAN's subnet mask	122
■	Setting the LAN's default gateway	123
■	Displaying the LAN's MAC address	124
■	Connecting the instrument to a computer with a LAN cable	125
4.1.2	Using the RS-232C Interface	127
■	Setting the RS-232C communications speed	128
■	Connecting the RS-232C Cable	129
4.1.3	Using the GP-IB Interface	131
■	Connecting the GP-IB Cable	132
■	Setting the GP-IB address	133
4.2	Operating the Instrument from a PC's Browser (LAN only)	134
■	Operating the instrument remotely	135
4.3	Canceling the Remote State (Activating the Local State)	137
■	Canceling the remote state	137

Chapter 5 Specifications 139

5.1	Environmental and Safety Specifications	139
5.2	General Specifications	140
5.3	Measurement specifications	142
5.4	Functional Specifications	158
5.5	Calculation Formulas Specifications ..	163

Chapter 6 Maintenance and Service 167

6.1	Troubleshooting	168
6.2	Error Indication	170

Appendix **A1**

Appendix 1	Detailed Specifications of Measurement Items (Display Items)	A1
Appendix 2	Detailed Specifications of Output	A2
Appendix 2.1	Detailed Specifications of Level Output	A2
Appendix 2.2	Detailed Specifications of High-speed Level Output	A3
Appendix 2.3	Detailed Specifications of Waveform Output	A3
Appendix 3	Example Accuracy Calculations	A4
Appendix 4	Rack Mounting	A5
Appendix 5	Dimensional Diagram.....	A9
Appendix 6	Terminology	A10

Index **Index1**

Introduction

Thank you for purchasing the HIOKI PW3335, PW3335-01, PW3335-02, PW3335-03, PW3335-04 Power Meter. To obtain maximum performance from the instrument software, please read this manual first, and keep it handy for future reference.

PW3335	PW3335-01	PW3335-02	PW3335-03	PW3335-04	Show the model that is equipped with each function as the icon.
--------	-----------	-----------	-----------	-----------	---

The models are classified according to the factory-installed options as follows.

● : Installed — : Not installed

Model	Standard equipment	Factory-installed options			
	LAN	RS-232C	GP-IB	D/A output	External current sensor input
PW3335	●	●	—	—	—
PW3335-01	●	—	●	—	—
PW3335-02	●	●	—	●	—
PW3335-03	●	●	—	—	●
PW3335-04	●	●	●	●	●

You can check the model number on the rear of the instrument.

See: "Rear" (p.18)

Model PW3335-03 and PW3335-04 can measure relatively high current with the use of HIOKI Clamp on Sensors (clamp sensors), which are option, or current sensors. Hereafter, those sensors are collectively referred to as "current sensors". Please read the instruction manuals of each sensor for details before using.

The current sensors are classified as either "TYPE.1" or "TYPE.2" according to the output specifications.

Using a TYPE.2 current sensor requires Model 9555-10 Sensor Unit, which is option. Please refer to the instruction manual of Model 9555-10 for details.

See: "3.8 Using a Current Sensor" (p.100)

Trademark

- Microsoft and Internet Explorer are either registered trademarks or trademarks of Microsoft Corporation in the United States and other countries.
- Bluetooth® is a registered trademark of Bluetooth SIG, Inc.(USA). The trademark is used by HIOKI E.E. CORPORATION under license.
- Parani™ is a trademark of Sena Technologies Inc.

Confirming Package Contents

When you receive the instrument, inspect it carefully to ensure that no damage occurred during shipping. In particular, check the accessories, panel switches, keys, and connectors. If damage is evident, or if it fails to operate according to the specifications, contact your authorized Hioki distributor or reseller.

Store the packaging in which the instrument was delivered, as you will need it when transporting the instrument.

Instrument and accessories

Confirm that these contents are provided.

Example: PW3335

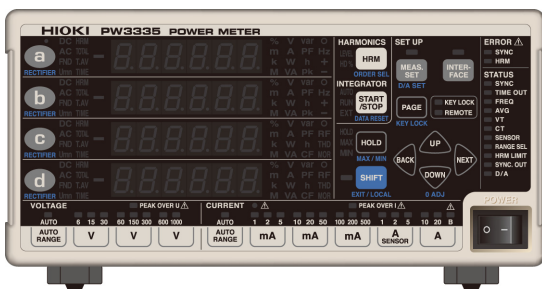

- PW3335, PW3335-01, PW3335-02, PW3335-03, PW3335-04 Power Meter
- Instruction manual
- Power cord
- Voltage and current input terminal safety cover ×2
- Safety cover installation screws (M3×6 mm) ×4

Options (sold separately)

The following options are available for the instrument. Contact your authorized Hioki distributor or reseller when ordering.

Communications and control options

- Model 9637 RS-232C Cable (9pin-9pin/ 1.8 m, crossover cable)
- Model 9638 RS-232C Cable (9pin-25pin/ 1.8 m, crossover cable)
- Model 9642 LAN Cable(5 m, Supplied with Cross-Over Adapter)
- Model 9151-02 GP-IB Connector Cable (2 m)
- Model 9165 Connection Cord (1.5 m, metal BNC to metal BNC, not CE marked, for the synchronized measurements)

Current sensor options

- Model 9661 Clamp on Sensor (500 A AC)
- Model 9669 Clamp on Sensor (1000 A AC)
- Model 9660 Clamp on Sensor (100 A AC)
- Model CT9667 Flexible Clamp on Sensor (500 A/5000 A AC)
- Model 9555-10 Sensor Unit
- Model L9217 Connection Cord
- Model 9272-10 Clamp on Sensor (20 A/200 A AC)
- Model 9277 Universal Clamp on CT (20 A AC/DC)
- Model 9278 Universal Clamp on CT (200 A AC/DC)
- Model 9279 Universal Clamp on CT (500 A AC/DC)
- Model 9709 AC/DC Current Sensor (500 A AC/DC)
- Model CT6862 AC/DC Current Sensor (50 A AC/DC)
- Model CT6863 AC/DC Current Sensor (200 A AC/DC)
- Model CT6865 AC/DC Current Sensor (1000 A AC/DC)
- Model CT6841 AC/DC Current Probe (20 A AC/DC)
- Model CT6843 AC/DC Current Probe (200 A AC/DC)

Safety Information

This instrument is designed to conform to IEC 61010 Safety Standards, and has been thoroughly tested for safety prior to shipment. However, using the instrument in a way not described in this manual may negate the provided safety features.

Before using the instrument, be certain to carefully read the following safety notes.



Mishandling during use could result in injury or death, as well as damage to the instrument. Be certain that you understand the instructions and precautions in the manual before use.



With regard to the electricity supply, there are risks of electric shock, heat generation, fire, and arc discharge due to short circuits. If persons unfamiliar with electricity measuring instruments are to use the instrument, another person familiar with such instruments must supervise operations.

Notation



In this manual, the risk seriousness and the hazard levels are classified as follows.

	DANGER	Indicates an imminently hazardous situation that will result in death or serious injury to the operator.
	WARNING	Indicates a potentially hazardous situation that may result in death or serious injury to the operator.
	CAUTION	Indicates a potentially hazardous situation that may result in minor or moderate injury to the operator or damage to the instrument or malfunction.
	IMPORTANT	Indicates information related to the operation of the instrument or maintenance tasks with which the operators must be fully familiar.
		Indicates a high voltage hazard. If a particular safety check is not performed or the instrument is mishandled, this may give rise to a hazardous situation; the operator may receive an electric shock, may get burnt or may even be fatally injured.
		Indicates prohibited actions.
		Indicates the action which must be performed.
*		Additional information is presented below.

Symbols affixed to the instrument

	Indicates cautions and hazards. When the symbol is printed on the instrument, refer to a corresponding topic in the Instruction Manual.
	Indicates the ON side of the power switch.
	Indicates the OFF side of the power switch.
	Indicates a grounding terminal.
	Indicates AC (Alternating Current).

Symbols for various standards

	Indicates the Waste Electrical and Electronic Equipment Directive (WEEE Directive) in EU member states.
	This symbol indicates that the product conforms to regulations set out by the EU Directive.

Other Symbols

(p.)	Indicates the location of reference information.
SET (Boldface)	Bold-faced alphanumeric characters in the text indicate characters shown on the operation keys and display panel.

Screen display

The screen of this instrument displays characters in the following manner.

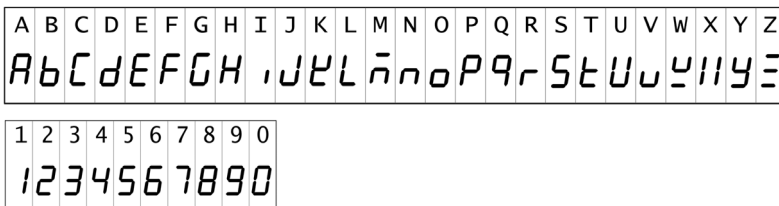

Accuracy

We define measurement tolerances in terms of f.s. (full scale), rdg. (reading) and dgt. (digit) values, with the following meanings:

f.s. (range)	This is usually the name of the currently selected range.
rdg. (reading or displayed value)	The value currently being measured and indicated on the measuring instrument.
dgt. (resolution)	The smallest displayable unit on a digital measuring instrument, i.e., the input value that causes the digital display to show a "1" as the least-significant digit.

For example accuracy calculations, see "Appendix 3 Example Accuracy Calculations" (p. A4).

Measurement categories

To ensure safe operation of measuring instruments, IEC 61010 establishes safety standards for various electrical environments, categorized as CAT II to CAT IV, and called measurement categories.



- Using a measuring instrument in an environment designated with a higher-numbered category than that for which the instrument is rated could result in a severe accident, and must be carefully avoided.
- Using a measuring instrument without categories in an environment designated with the CAT II to CAT IV category could result in a severe accident, and must be carefully avoided.

This instrument conforms to the safety requirements for CAT II 1000 V, CAT III 600 V measuring instruments.

CAT II	When directly measuring the electrical outlet receptacles of the primary electrical circuits in equipment connected to an AC electrical outlet by a power cord (portable tools, household appliances, etc.)
CAT III	When measuring the primary electrical circuits of heavy equipment (fixed installations) connected directly to the distribution panel, and feeders from the distribution panel to outlets
CAT IV	When measuring the circuit from the service drop to the service entrance, and to the power meter and primary overcurrent protection device (distribution panel)

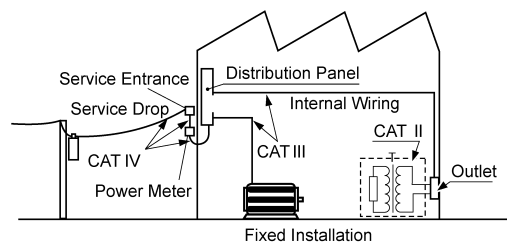

Operating Precautions

Follow these precautions to ensure safe operation and to obtain the full benefits of the various functions.

Before Use



If the connection cable or the instrument is damaged, there is a risk of electric shock. Before using the instrument, perform the following inspection.

- Before using the instrument, check that the coating of the connection cables are neither ripped nor torn and that no metal parts are exposed. Using the instrument under such conditions could result in electrocution or a short-circuit. Replace the connection cables with those specified by our company.
- Before using the instrument for the first time, verify that it operates normally to ensure that no damage occurred during storage or shipping. If you find any damage, contact your authorized Hioki distributor or reseller.

To measure accurately

- Warm up the instrument for more than 30 minutes before use.
- To maintain sufficient measurement accuracy of the instrument, be sure to help heat radiation.
Example: Keeping away the instrument from a heat, leaving sufficient clearances around the instrument, installing cooling fans to the rack in which the instrument is mounted, or other measures.

Instrument Installation

For more information about the operating temperature and humidity range and the storage temperature and humidity range, see "Chapter 5 Specifications" (p.139).

! WARNING



Avoid the following locations that could cause an accident or damage to the instrument.

- Exposed to direct sunlight or high temperature
- Exposed to corrosive or combustible gases
- Exposed to water, oil, chemicals, or solvents
- Exposed to high humidity or condensation
- Exposed to a strong electromagnetic field or electrostatic charge
- Exposed to high quantities of dust particles
- Near induction heating systems (such as high-frequency induction heating systems and IH cooking equipment)
- Susceptible to vibration

! CAUTION



Ventilation holes for heat radiation are provided on the side and rear panels of the instrument. Leave sufficient space around the ventilation holes and install the instrument with the holes unobstructed. Installation of the instrument with the ventilation holes obstructed may cause a malfunction or fire.



Do not place another PW3335 or measuring instrument or other heat-generating device underneath or on top of this instrument. Doing so may damage the instrument or cause burns or fire.

Installing

To prevent overheating, be sure to leave the specified clearances around the unit.

- The instrument should be operated only with the bottom downwards.
- Vents must not be obstructed.

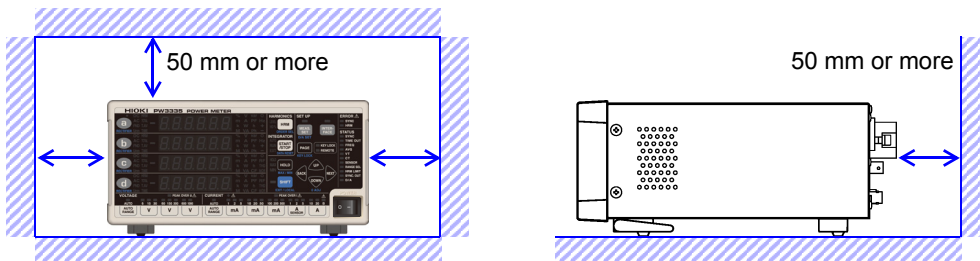

- Correct measurement may be impossible in the presence of strong magnetic fields, such as near transformers and high-current conductors, or in the presence of strong electromagnetic fields such as near radio transmitters.
- Unplugging the power cord kills power to the instrument. Be sure to provide enough unobstructed space to unplug the power cord immediately in an emergency.
- The instrument can be used with the stands flipped out.(p.19)
- To mount the instrument in a rack, refer to "Appendix 4 Rack Mounting" (p. A5)

Handling the Instrument

DANGER



To avoid electric shock, do not remove the instrument's case. The internal components of the instrument carry high voltages and may become very hot during operation.

WARNING



Do not allow the instrument to get wet, and do not take measurements with wet hands. This may cause an electric shock.

CAUTION



- To avoid damage to the instrument, protect it from physical shock when transporting and handling. Be especially careful to avoid physical shock from dropping.
- After use, always turn OFF the power.

This instrument may cause interference if used in residential areas. Such use must be avoided unless the user takes special measures to reduce electromagnetic emissions to prevent interference to the reception of radio and television broadcasts.

Handling the Cables

DANGER



If the insulation on a cable melts, the metal conductor may be exposed. Do not use any cable whose metal conductor is exposed. Doing so could result in electric shock, burns, or other hazard.

WARNING



- Do not move wires connected to the voltage input terminals or current input terminals unnecessarily. Doing so may loosen the connection between the wires and terminals, causing the terminals to heat or melt due to increased contact resistance and posing the risk of an electrical accident or electric shock.
- Do not tie the cables connected to the input terminals in a bundle with the power supply cord, the communication cables, the external I/O wires, or the current sensor cables. Doing so may result in a short-circuit, electric shock, or instrument malfunction.

CAUTION



- Avoid stepping on or pinching cables, which could damage the cable insulation.
- To avoid breaking the cables, do not bend or pull them.



- To avoid damaging the power cord, grasp the plug, not the cord, when unplugging it from the power outlet.

Connecting, Input and Measurement

DANGER



- **The maximum input voltage is 1000 V DC/AC and the maximum input current to the current input terminals is 30 A DC/AC.**
Attempting to measure a voltage or current in excess of each of the maximum inputs could destroy the instrument and result in personal injury or death.
- **The maximum rated voltage between input terminals and the ground is as follows:**
(CAT II) 1000 V DC, 1000 V AC
(CAT III) 600 V DC, 600 V AC
Attempting to measure voltages exceeding this level with respect to ground could damage the instrument and result in personal injury.
- The external current sensor input terminals are not insulated. The terminals are exclusive to the optional current sensors. To prevent instrument damage and bodily injury, do not connect any device other than an optional current sensor.
- To avoid the danger of electric shock, do not input a signal in excess of the ratings to the external I/O terminals.



- **This instrument should only be connected to the secondary side of a breaker,** so the breaker can prevent an accident if a short circuit occurs. Connections should never be made to the primary side of a breaker, because unrestricted current flow could cause a serious accident if a short circuit occurs.
- To avoid electrical accidents, confirm that **all terminals are secure.** The increased resistance of loose connections can lead to overheating and fire.
(Tightening torque of the input terminals: 3 Nm)

Safety covers

- The safety covers play a protective role by preventing contact with the terminals. Always attach the safety covers before using the instrument.
- Turn off the supply of power to measurement lines before attaching or removing the safety covers.

⚠ WARNING**When connecting**

Observe the following to avoid electric shock and short circuits.

- Turn off the power to lines to be measured before making connections to input terminals and turning on the instrument.
- When making connections, do not mix up the voltage input terminals (U) and the current input terminals (I). In particular, do not input a voltage across the current input terminals (between I and \pm). Using the instrument with a faulty wiring will damage the instrument or cause injury.
- Be careful to avoid shorting between the voltage input terminals with the wires.

When abnormalities such as smoke, unusual noise, or unusual odor are observed

Stop the measurement immediately, and observe the following procedure. Using the instrument in such a abnormal condition could cause death or injury.

1. Turn off the power to the instrument.
2. Disconnect the power cord from the outlet.
3. Turn off the power to the line to be measured.
Remove the measurement cables.
4. Contact your authorized Hioki distributor or reseller.

When connecting cables to the input terminals, the communication connectors, or the external I/O terminals, observe the following to avoid electric shock and short circuits.

- Always turn off the power to the instrument and any device to be connected before making connections.
- Be careful to avoid exceeding the ratings of the input terminals or external control terminals.
- During operation, a wire becoming dislocated and contacting another conductive object can be serious hazard. Use the screws to secure the communication connectors.

⚠ CAUTION

For safety reasons, disconnect the power cord when the instrument is not used and before connecting it to a device to be tested.

- To avoid damage to the instrument, do not input the voltage to the output terminals. Also do not short between any terminals.
- When the instrument is turned off, do not apply voltage or current to the instrument. Doing so may cause the instrument to become hot, resulting in burns or damage to the instrument. (p.36)
- Do not connect or disconnect the current sensor or disconnect or connect the connection cord from the 9555-10 Sensor Unit while power is being supplied to the instrument or 9555-10. Doing so may damage the instrument, current sensor, or 9555-10.
- Do not input current to the current sensor when it is not connected to the instrument or when the instrument and 9555-10 Sensor Unit are turned off. Doing so may damage the current sensor, instrument, or 9555-10 Sensor Unit.

The instrument and input terminals may become hot when a large voltage or current is input.

Before Turning Power On

WARNING



- Before turning the instrument on, make sure the supply voltage matches that indicated on its power connector. Connection to an improper supply voltage may damage the instrument and present an electrical hazard.
- To avoid electrical accidents and to maintain the safety specifications of this instrument, connect the power cord provided only to a 3-contact (two-conductor + ground) outlet.

See: Connection Methods: "2.3 Connecting the Power Cord" (p.33)

See:

CAUTION



Avoid using an uninterruptible power supply (UPS) or DC/AC inverter with rectangular wave or pseudo-sine-wave output to power the instrument. Doing so may damage the instrument.

Overview

Chapter 1

1.1 Product Overview

The PW3335 is a power meter that can be used to perform power measurements for single-phase devices such as battery-driven devices and household electronics.

Thanks to its broad selection of current ranges from 1 mA to 20 A (with an effective measurement range of 10 μ A to 30 A), it comprises a single-device solution for measuring parameters ranging from standby power consumption to power consumption during normal operation of devices such as household electronics.

1.2 Features

■ Guaranteed accuracy up to 30 A with direct input

- Accuracy is guaranteed for currents of up to 30 A with direct input.
- (The maximum input current is 30 A, ± 100 A peak.)
- An optional current sensor can be used to measure currents in excess of 30 A. (p.100)

■ High-accuracy, wide-band performance

- The instrument delivers a high fundamental accuracy of $\pm 0.15\%$ rdg. (at less than 50% of range, $\pm 0.1\%$ rdg. $\pm 0.05\%$ f.s.).
- Over a wide band from DC and 0.1 Hz to 100 kHz, the instrument covers not only the fundamental frequency band for inverter-driven equipment, but also the carrier frequency band.
- Power factor effects are low at $\pm 0.1\%$ f.s. or less (with a internal circuit voltage/current phase difference of $\pm 0.0573^\circ$), allowing high-accuracy measurement of active power during low power-factor operation, for example during no-load testing of transformers and motors.

■ Standard harmonic measurement function compliant with IEC 61000-4-7:2002 (p.71)

- The instrument can perform harmonic measurement compliant with the IEC 61000-4-7:2002 international standard on harmonic measurement methods.
- You can set an upper limit for the analyzed order from the 2nd to 50th order according to the harmonic measurement standard in use.

■ Extensive measurement functionality, standard

- Since processing for functions such as AC+DC (RMS), AC+DC U_{mn} (voltage average value rectified RMS equivalent), DC (DC component), AC (AC component), FND (fundamental wave component), and harmonic measurement as well as integration measurement can be performed internally and in parallel, it is possible to obtain simultaneous measured values simply by switching the display.

■ High-speed D/A output to capture harsh load variations (p.85)

PW3335-02 PW3335-04

- The PW3335 can generate level (analog) output for each cycle of an input voltage or input current. Additionally, The active power level can be output for each cycle for the voltage or current assigned to the synchronization source.
- Variations over extended periods of time can be recorded by using the instrument in conjunction with equipment such as a recorder or data logger using level output (updated every 200 ms) to measure parameters such as voltage, current, and active power.
- Safe, insulated waveforms can be observed using waveform output (equivalent to a sampling rate of approximately 700 kHz) instantaneous voltage, instantaneous current, and instantaneous power.

■ Building a system with 3 interfaces (p.119)

- You can control the instrument or capture data from it using a computer by using the LAN interface (standard) or RS-232C interface (excluding PW3335-01). (You can also communicate with a computer over USB by using a commercially available USB serial [RS232-C] conversion cable.)
- The instrument is also available with a GP-IB interface, which is essential for system development.

(PW3335-01 PW3335-04)

■ Synchronized control function with support for measurement of multiple circuits (p.78)

- Simultaneous measurement can be performed by connecting two instruments with an optional BNC cable.
 - Calculations, display updates, data updates, integration control, display hold timing, zero-adjustment, and key lock operation of the instrument set as the slave (IN setting) are matched to the master instrument (OUT setting).
 - Up to eight instruments can perform simultaneous measurement, including the PW3336 and the PW3337 series of power meters.
-

1.3 Names and Functions of Parts

Front Panel

Example:
PW3335-04

Parameter keys (p.14)

Switch display parameters.

RECTIFIER (p.42)

Switches the rectifier in the shift state.

Display

Switches between measured values and setting values.

HRM (ORDER SEL)

Harmonic display (switch among level, content percentage, and normal display) (Choose the order you wish to display in the shift state.)

START/STOP (DATA RESET)

Starts/stops integration (resets integrated values in the shift state).

HOLD (MAX/ MIN)

Holds display values (switches between maximum and minimum values in the shift state).

SHIFT (EXIT/ LOCAL)

Activates the SHIFT state (the lamp will light up while in the SHIFT state). (p.14)

(Switches from settings mode to the normal measurement state and from the remote state to the local state.)

Function setting keys (p.17)

Configure functions.

Error lamps (p.17)

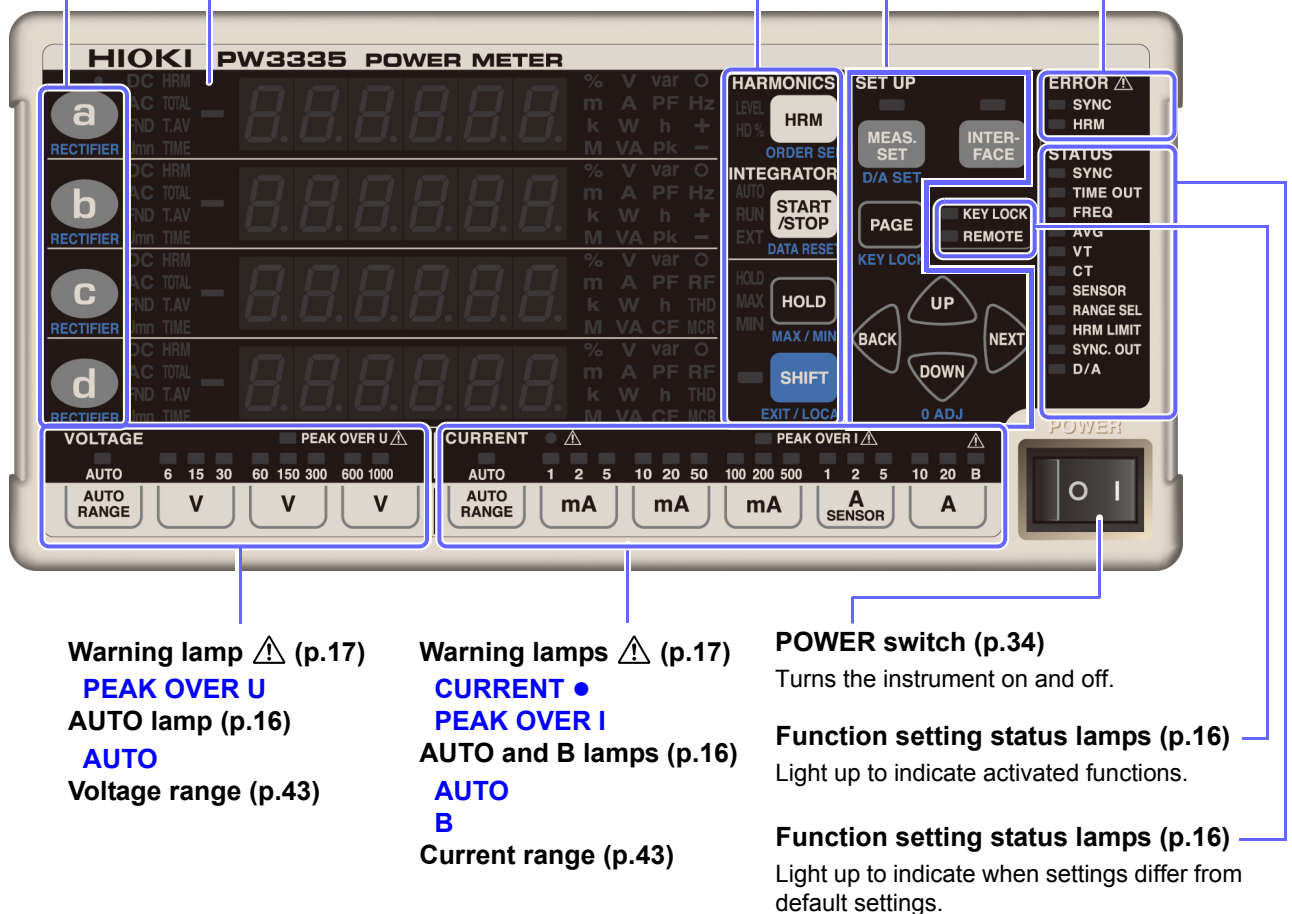

- The shift state is automatically canceled after Approx. 10 seconds. When the **RECTIFIER** key is pressed, the shift state is canceled after Approx. 2 seconds.
- If key operation causes a message or indication that is not described in this manual to be displayed, immediately cycle the instrument's power.

Activates the SHIFT state



Press **SHIFT** to light up the blue lamp before setting functions shown in blue underneath keys.

Display parameters

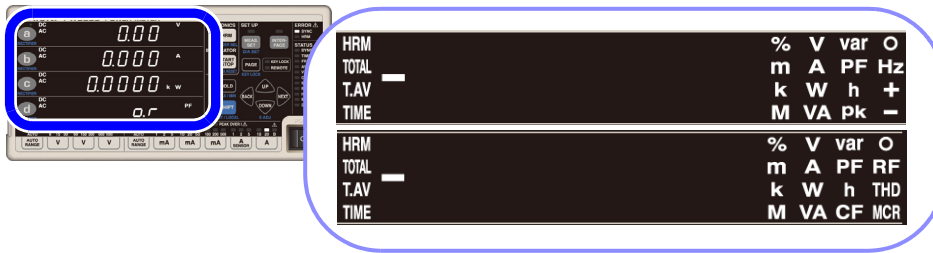

Pressing **a** on the first row, **b** on the second row, **c** on the third row, or **d** on the fourth row of the measured value display switches the display parameter, causing the selected display parameter to light up.

V	Voltage (U)
A	Current (I)
W	Active power (P)
VA	Apparent power (S)
var	Reactive power (Q)
PF	Power factor (λ)
°	Phase angle (ϕ)
V Hz	Voltage frequency (f)
A Hz	Current frequency (f)
Ah +	Positive current integration
Ah -	Negative current integration
Ah	Current integration sum
Wh +	Positive active power integration
Wh -	Negative active power integration
Wh	Active power integration sum
TIME	Integration time
V pk	Voltage waveform peak value (Upk)
A pk	Current waveform peak value (Ipk)

CF V	Voltage crest factor (Ucf)
CF A	Current crest factor (Icf)
MCR	Maximum current ratio
T.AV A	Time average current (T.AV I)
T.AV W	Time average active power (T.AV P)
RF V %	Voltage ripple rate (Urf)
RF A %	Current ripple rate (Irf)
THD V %	Total harmonic voltage distortion (Uthd)
THD A %	Total harmonic current distortion (Ithd)
HRM V LEVEL	Harmonic voltage RMS value (Uk)
HRM A LEVEL	Harmonic current RMS value (Ik)
HRM W LEVEL	Harmonic active power (Pk)
HRM V % HD%	Harmonic voltage content percentage (UHDk)
HRM A % HD%	Harmonic current content percentage (IHDk)
HRM W % HD%	Harmonic active power content percentage (PHDk)

Rectifier indicator lamps (p.42)



DC AC	When using the AC+DC rectifier, both the DC and AC lamps light up.
DC AC Umn	When using the AC+DC Umn rectifier, the DC, AC, and Umn lamps light up.
DC	Lights up when using the DC rectifier.
AC	Lights up when using the AC rectifier.
FND	Lights up when using the FND rectifier.

Harmonic measurement (HARMONICS) lamps (p.71)



LEVEL	Lights up when the instrument is displaying a harmonic component level (harmonic voltage RMS value, harmonic current RMS value, or harmonic active power).
HD%	Lights up when the instrument is displaying a harmonic content percentage (harmonic voltage content percentage, harmonic current content percentage, or harmonic active power content percentage).

Integration (INTEGRATOR) status indicator lamps (p.61)

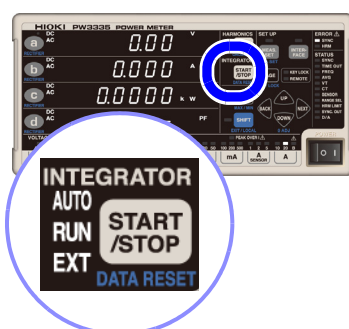

AUTO	Indicates the integration operating mode. AUTO lamp on: Auto-range integration mode AUTO lamp off: Fixed-range integration mode
RUN	Indicates the status of integration based on START/STOP key operation or communications. RUN lamp on: Integration active RUN lamp flashing: Integration stopped RUN lamp off: Integration reset
RUN EXT	Indicates the status of integration based on external control. RUN lamp on, EXT lamp on: Integration active RUN lamp flashing, EXT lamp on: Integration stopped RUN lamp off, EXT lamp off: Integration reset

Hold (HOLD) status indicator lamp (p.106)

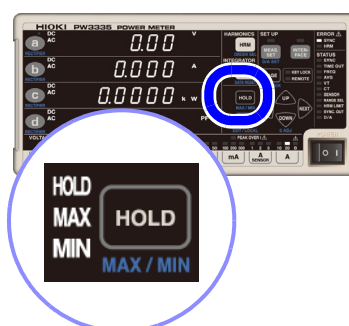

HOLD	When the HOLD , MAX , and MIN lamps are all off, pressing the SHIFT key and then HOLD causes the instrument to enter the display hold state and the HOLD lamp to light up. To cancel display hold: Pressing HOLD once more causes the display hold state to be canceled and the HOLD lamp to be turned off.
MAX	When the HOLD , MAX , and MIN lamps are all off, pressing SHIFT and then HOLD causes the maximum value to be held and the MAX lamp to light up.
MIN	Pressing HOLD while the MAX lamp is lit up (indicating that the maximum value is being held) causes the minimum value to be held and the MIN lamp to light up. Pressing HOLD while the MIN lamp is lit up (indicating that the minimum value is being held) causes the minimum value hold to be canceled, returning to the normal measured value display.

Function setting status lamps

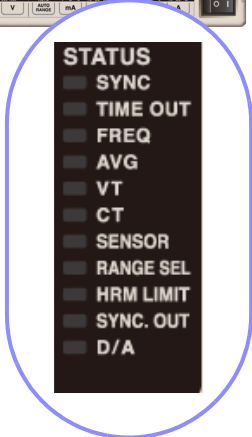

These lamps indicate the setting status.
Function lamps light up when set to a value other than the default setting.

SYNC	Lights up when the synchronization source is set to I or DC (the default setting is voltage: U). (p.48)
TIME OUT	Lights up when the synchronization detection timeout is set to 1 sec. or 10 sec. (the default setting is 0.1 sec.). (p.54)
FREQ	Lights up when the zero-cross and frequency measurement filter setting is set to 100 Hz, 5 kHz, or 100 kHz (the default setting is 500 Hz). (p.50)
AVG	Lights up when the number of averaging iterations is set to a value other than the default value of 1. (p.56)
VT	Lights up when the VT ratio setting is set to a value other than the default setting of 1. (p.58)
CT	Lights up when the CT ratio setting is set to a value other than the default setting of 1. (p.58)
SENSOR	Lights up when the current input method setting is set to TYPE.1 or TYPE.2 (current sensor input) (the default setting is OFF [current value direct input]). (p.38)
RANGE SEL	Lights up when either the voltage measurement range or current measurement range is set to OFF. (the default setting is range select: ON). (p.46) Lights up when any of the zero-cross threshold levels is set to a value other than the default setting of 1%. (p.52)
HRM LIMIT	Lights up when the harmonic analysis order upper limit is set to a value other than the default value of 50. (p.76)
SYNC. OUT	Lights up when the synchronized measurement I/O setting is set to OUT (Master). Flashes with external synchronized signal input when set to IN (Slave). Turns off when set to OFF. (p.78)
D/A	PW3335-02 PW3335-04 Lights up when the 7 channels of D/A output are set to values other than their default values. (p.88)

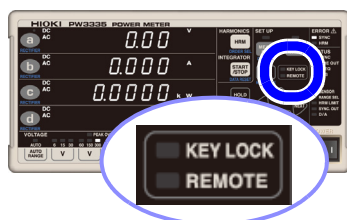

These lamps indicate the instrument's overall setting status.
They light up when the corresponding function is ON.

KEY LOCK	Lights up when key operation is disabled. (p.109)
REMOTE	Lights up when the instrument is in remote operation mode. (p.137)

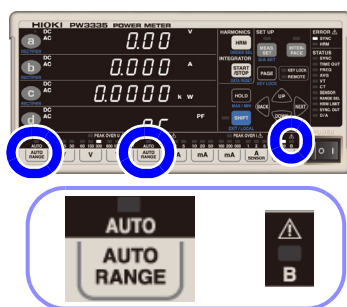

AUTO	Lights up when the voltage or current measurement range is set to auto range (the default setting is auto range OFF). (p.43)
B	Indicates the B 20 A range used in auto-range integration mode. Lights up when a range is selected while integration is stopped. (p.61)



WARNING When the VT and CT lamps are lit up (particularly when the VT ratio and CT ratio are set to values less than 1), a voltage or current greater than the displayed measured value may have been input to the instrument. To prevent an electrical accident or short-circuit, do not unnecessarily touch the instrument's input terminal or the measurement lines.

Warning ⚠ indicator lamps

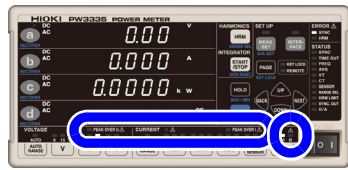

The following warning lamps are lit up when there is a hazard or the instrument is unable to perform measurement accurately:

PEAK OVER U	Lights up when an overvoltage input warning occurs, indicating that the input voltage peak value has exceeded $\pm 1,500$ V or $\pm 600\%$ of the voltage measurement range.
PEAK OVER I	Lights up when an overcurrent input warning occurs, indicating that the input current peak value has exceeded ± 100 A or $\pm 600\%$ of the current measurement range.
CURRENT ●	Instrument protection mode. Flash when if current of greater than or equal to ± 612 mA peak is inputted continuously for 10 or more seconds when using a range from 1 mA to 100 mA with fixed range. If you attempt to switch from one of the 200 mA to 20 A ranges to one of the 1 mA to 100 mA ranges while a current of ± 612 mA peak or greater is being input, you will not be able to switch ranges, and the indicator will flash.

Error indicator lamps

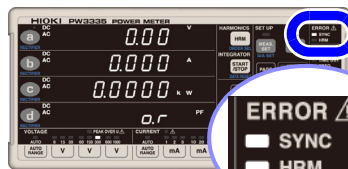







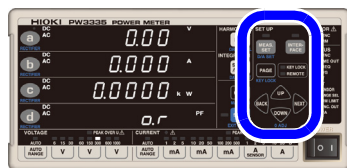

The following error lamps are lit up when the instrument is unable to perform measurement accurately:

SYNC	Lights up when a synchronization error occurs, indicating that synchronization cannot be detected. (p.48)
HRM	Lights up when a harmonic measurement synchronization error occurs, indicating that the harmonic measurement synchronization frequency range was exceeded. (p.71)

Function setting keys and indicator lamps



MEAS. SET 	The lamp will light up if pressed when the following settings are being configured: <ul style="list-style-type: none"> • Synchronization source • Current input method • Range select • CT ratio • VT ratio • Frequency measurement range (zero-cross filter) • Synchronization detection timeout • Integration time, auto-range integration • Number of averaging iterations • Harmonic analysis upper limit order • Synchronized measurement I/O (master, slave) • D/A output PW3335-02 PW3335-04
INTERFACE 	The lamp will light up if pressed when setting the interface. <ul style="list-style-type: none"> • LAN • RS-232C PW3335 PW3335-02 PW3335-03 PW3335-04 • GP-IB PW3335-01 PW3335-04
PAGE KEY LOCK 	<ul style="list-style-type: none"> • Used to switch among settings configured with  and . • Used with the key lock function.
	Used to move among and select settings. <ul style="list-style-type: none"> • Pressing and holding  or  will cause the flashing setting to move successively.

Rear

Example: PW3335-04

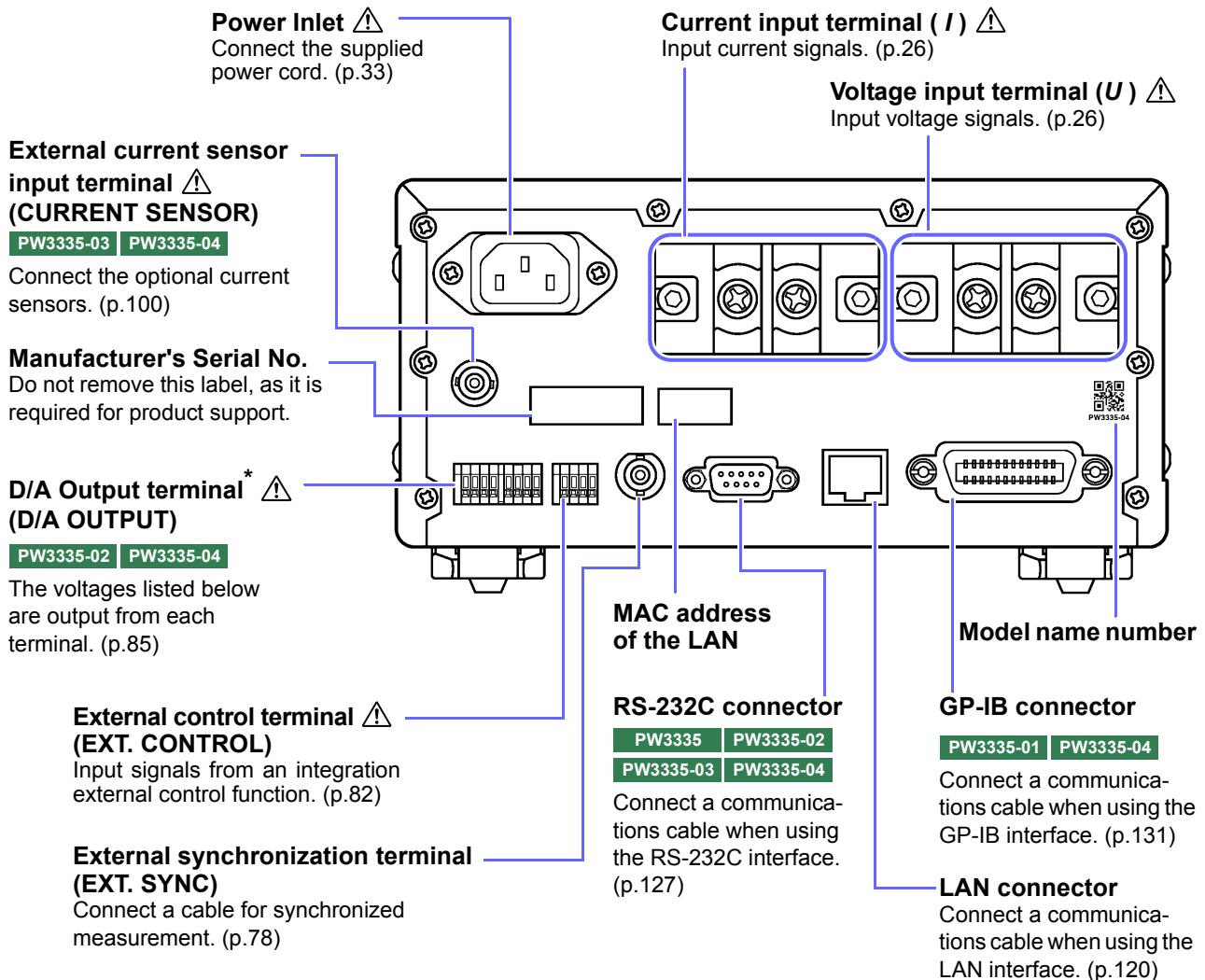

*D/A OUTPUT terminals

The following voltages are output from each terminal.

Level output: Level (analog) output is updated at an interval of approximately 200 ms.

High-speed level output: The active power for every cycle for the voltage or current set as the synchronization source is output.

Waveform output: The input waveform as sampled at a frequency of approximately 700 kHz is output.

Terminal	Default setting	Description
DA1	V : AC+DC, STD.2	Each D/A output terminal can be set to any of the following: <ul style="list-style-type: none"> • Level output • High-speed level output • Waveform output See: Appendix 2 Detailed Specifications of Output (p. A2)
DA2	A : AC+DC, STD.2	
DA3	W : AC+DC, STD.2	
DA4	PF : AC+DC, STD.2	
DA5	V : AC+DC, FAST	
DA6	A : AC+DC, FAST	
DA7	W : AC+DC, FAST	

Bottom panel

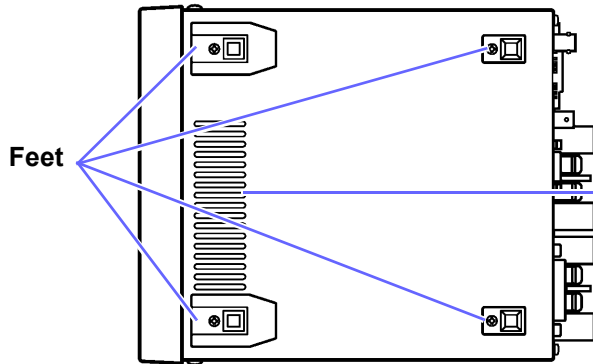

This instrument can be rack-mounted by removing its feet.

See: Appendix 4 Rack Mounting (p. A5)

Parts removed from this instrument should be stored in a safe place to enable future reuse.

Vents

Keep clear of obstructions.

Left side

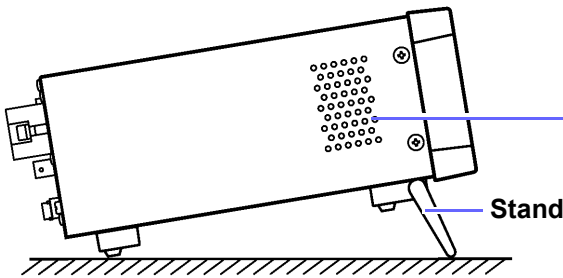

When using the stands

Open the stands until they clicks into place. Be sure to use both stands.

When folding up the stands

Fold up the stands until they click into place.

Right side

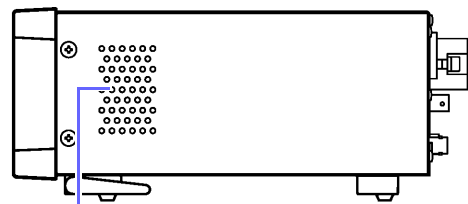

Vents

Keep clear of obstructions.

Clean the vents periodically to avoid blockage.



Do not apply heavy downward pressure with the stand extended. The stand could be damaged.

1.4 Measurement Workflow

1 Install the instrument, connect wires and cords, and turn on the instrument.

Installing the Instrument (p.6)

CHECKS

- Are the wires from the measurement targets shut off?
- Is the instrument turned off, and has the power cord been disconnected?

Connecting Wires and the Power Cord

Connect the measurement lines to the instrument and then connect the power cord to the instrument.

Connect wires. (p.26)

Example:

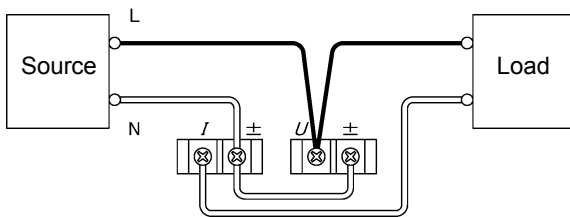

Connect the power cord. (p.33)

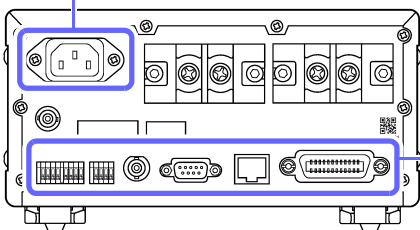

CHECKS

- Is the instrument connected on the secondary side of the circuit breaker?
- Does the circuit being used exceed 1,000 V?
- Does the voltage or current being measured exceed 1,000 V or 30 A, respectively? If so, use VT and CT.
- Are appropriate types of wire being used to connect to the voltage and current input terminals? Use solderless terminals that cover wiring with insulation. Moreover, use wire with adequate dielectric strength and current capacity.
- Has the wiring been shorted?
- Are the input terminals loose?
- Have wires been connected properly?

- Using D/A output(p.85)
- Using synchronized control to conduct measurements with multiple instruments simultaneously (p.78)
- Using external control to control integration (p.61)
- Sending and receiving data with the RS-232C, LAN, and GP-IB interfaces (p.119)

When using one or more current sensors, see "3.8 Using a Current Sensor" (p.100).

Turning on the instrument (p.34)

Before turning on the instrument, verify that the wires have been connected properly one more time. After displaying the initial screen, the instrument will display input values under the current settings.

Allow the instrument to warm up for at least 30 minutes.

Perform zero-adjustment.

To fulfill the instrument's accuracy specifications, be sure to perform zero-adjustment for the voltage and current measured values.

2 Configure settings. (These settings can also be changed during measurement.)

Setting the current input method (p.38)



Selecting display parameters (p.40)

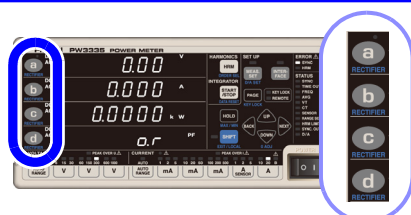

Selecting voltage and current ranges (p.43)

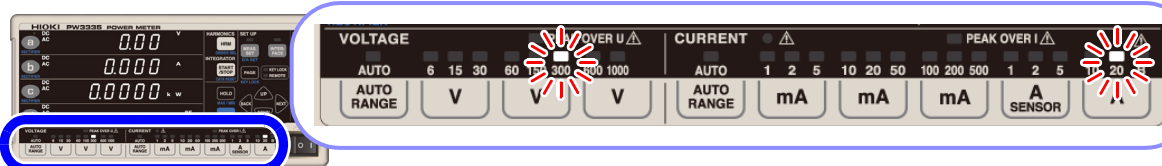

Setting the synchronization source (p.48)



Selecting rectifiers (p.42)



Configure the following settings as necessary:

- When **SYNC** lamp (ERROR) lights up: Setting the frequency measurement range
See: "3.2.5 Setting the Frequency Measurement Range (Zero-cross filter)" (p.50)

■ Addressing display value variation: Displaying average measured values

See: "3.2.7 Displaying Measured Values as an Average (AVG: Averaging)" (p.56)

■ Measuring voltages in excess of 1,000 V: Using VT (PT) to make measurements

See: "3.2.8 Setting the VT Ratio and CT Ratio" (p.58)

■ Measuring currents in excess of 30 A: Using CT to make measurements

See: "3.2.8 Setting the VT Ratio and CT Ratio" (p.58)

■ When you wish to perform integration

See: "3.3 Integration" (p.61)

■ When you wish to measure harmonics

See: "3.4 Viewing Harmonic Measured Values" (p.71)

■ When you wish to hold the display, or display the peak value, minimum value, or maximum value

See: "3.9.1 Fixing Display Values (Display Hold)" (p.106)

"3.9.2 Displaying Maximum, and Minimum Values (MAX/MIN)" (p.107)

■ When you wish to use D/A output PW3335-02 PW3335-04

See: "Output voltage of level output"(p.95)

■ When you wish to use the RS-232C interface

See: "Setting the RS-232C communications speed"(p.128)

■ When you wish to use the LAN interface

See: "Setting the LAN's IP address"(p.121)

■ When you wish to use the GP-IB interface PW3335-01 PW3335-04

See: "Setting the GP-IB address"(p.133)

■ When you wish to perform synchronized measurement with multiple instruments

See: "3.5 Performing Synchronized Measurement with Multiple Instruments (Multiple-instrument Synchronized Measurement)" (p.78)

3 Start measurement.

Activating power to the measurement lines

Measuring and outputting data

The instrument will display the measured values.

You can change the voltage and current range as well as display parameters during measurement.

Example:



■ When you wish to hold display values (p.106)

Press **HOLD**.

■ Displaying maximum and minimum values (p.107)

Press **HOLD** while holding down **SHIFT**.

MAX / MIN

4 Stop measurement.

Turning off the instrument

Turn off power to the measurement lines and after disconnecting the cords from the measurement target, turn off the instrument.

See: "2.4 Turning On the Instrument" (p.34)

About measured values

- The instrument's apparent power (S), reactive power (Q), power factor (λ), and phase angle (φ) are calculated based on the measured voltage (U), current (I), and active power (P). For the actual equations used, see "5.5 Calculation Formulas Specifications" (p.163). Values displayed by the instrument may differ from values displayed by measuring instruments that use different operating principles or equations.
- Voltage values that are less than $\pm 0.5\%$ of the measurement range and current values that are less than $\pm 0.5\%$ of the measurement range or less than $\pm 9 \mu\text{A}$ will be forcibly displayed as zero. (this is known as zero-suppression).
- Measured values may include an error component in measurements in which a terminal-to-ground voltage with a high frequency is input.
- Display values may exhibit variation in applications in which the frequencies of the voltage and current being measured differ.
- Measured values may include an error component when the instrument is used near a strong magnetic field such as that generated by a transformer or high-current path, a strong electric field generated by a radio or similar device, or a high-frequency magnetic field generated by a high-frequency current.

Measurement Preparations

Chapter 2

2.1 Installation and Connection Procedures

Please read "Operating Precautions" (p.5) carefully before installing or connecting the instrument. Verify that power to the measurement lines has been cut off before connecting the instrument to them.

- 1** Install the instrument (p.6)



- 2** Remove the safety covers.

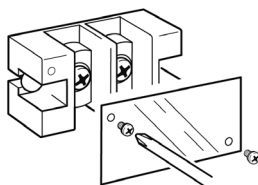

- 3** Connect the connection cables to the voltage input terminals and current input terminals. (p.26)

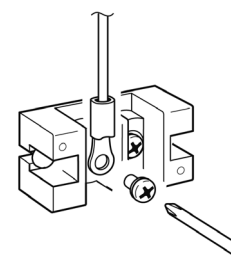

- 4** Reattach the safety covers.

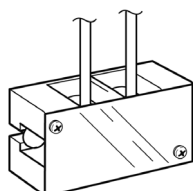

- 5** Connect the power cord. (p.33)

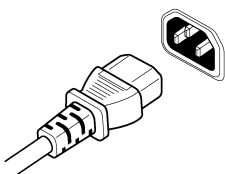

- 6** Turn the power on (p.34)

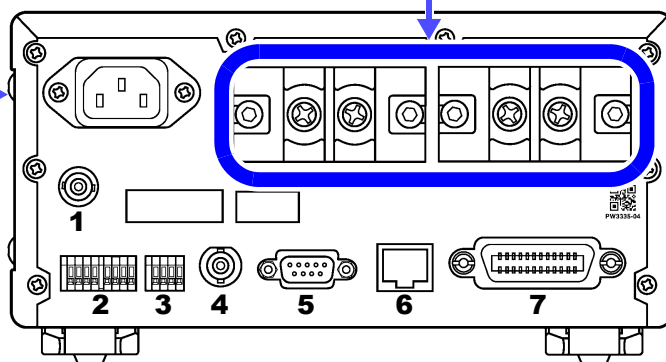

Configure the following settings as desired:

- 1:** When you wish to use an external current sensor (p.100)
- 2:** When you wish to use D/A output (p.85)
- 3:** When you wish to use external control (p.82)
- 4:** When you wish to perform synchronized measurement (p.78)
- 5:** When you wish to use the RS-232C interface (p.127)
- 6:** When you wish to use the LAN interface (p.120)
- 7:** When you wish to use the GP-IB interface (p.131)

- 7** Activate power to the measurement lines.

➤ After use, deactivate power to the measurement lines, disconnect cables, and turn off the instrument.

2.2 Connecting the Measurement Lines

Please read "Handling the Cables" (p.7) carefully before installing, connecting the measurement lines, or connecting the instrument.



WARNING Verify that power to the measurement lines has been cut off before connecting the instrument to them.

To ensure accurate measurement

- When measuring power, the polarity of the voltage and current affects readings, so it is essential to connect the instrument to the measurement lines properly. Accurate measurement will not be possible if these connections are not made properly.
- Route connected cables away from the instrument so that the electromagnetic field emitted by the cables does not affect the instrument's performance.

If the measurement target's voltage and current levels exceed the instrument's measurement range

By setting the VT ratio and CT ratio, you can read the measured current value (CT primary-side current) directly.

See: "3.2.8 Setting the VT Ratio and CT Ratio"(p.58)



DANGER To prevent electrical shock and personnel injury, do not touch any input terminals on the VT (PT), CT or the instrument when they are in operation.



- When using an external VT (PT): **Do not short the secondary side.** Applying a voltage to the primary side while the secondary side is shorted will cause a large current to flow to the secondary side, causing it to burn up and resulting in a fire.
- When using an external CT: **Do not leave the secondary side open.** Allowing a current to flow to the primary side while the secondary side is open will cause a high voltage to occur on the secondary side, which is extremely dangerous.

When using a VT (PT) or CT

- Phase differences between an external VT (PT) and CT can introduce a large error component into power measurements.
To ensure accurate power measurement, use a VT (PT) and CT with a small phase error in the frequency band of the circuit being used.
- To ensure safe operation, always ground the load side of the VT (PT) and CT (see figure below)

Wire materials (Voltage input terminal, Current input terminal)



WARNING To avoid electric shock or a short-circuit at the input terminals, use **solderless terminals that cover wiring with insulation.**
(Screws for voltage input terminals and current input terminals: M6)



CAUTION To avoid electric shock, use wiring with adequate dielectric strength and current capacity.

Connecting the measurement lines

Please read "Handling the Instrument" (p.7) carefully before connecting the instrument to the measurement lines.

! DANGER



Safety covers

Observe the following to avoid electric shock and short circuits.

- The safety covers play a protective role by preventing contact with the terminals. Always attach the safety covers before using the instrument.
- Turn off power to measurement lines before attaching or removing the safety covers.

! WARNING



- Verify that power to the measurement lines has been cut off before connecting the instrument to them.
- To avoid electric shock or a short-circuit at the input terminals, use solderless terminals that cover wiring with insulation.
- To prevent instrument damage or electric shock, use only the screws (M6×12 mm) for securing the voltage input terminals and current input terminals in place and the screws (M3×6 mm) for securing the safety cover in place that shipped with the product. If you lose any screw or find that any screws are damaged, please contact your Hioki distributor for a replacement.

Connect cables to the instrument's voltage input terminals and current input terminals.

- Use a Phillips head screwdriver with a No.3 tip. The screws' tightening torque is 3 N•m.
- Use solderless terminals with a width of 13 mm or less.
- Tighten screws securely.

1 Remove the safety covers from the voltage input terminals and current input terminals.

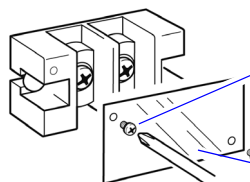

1 Remove the screws. (M3×6 mm)

2 Remove the safety cover.

2 Connect the cables to the voltage input terminals and current input terminals.

Example: Voltage input terminal

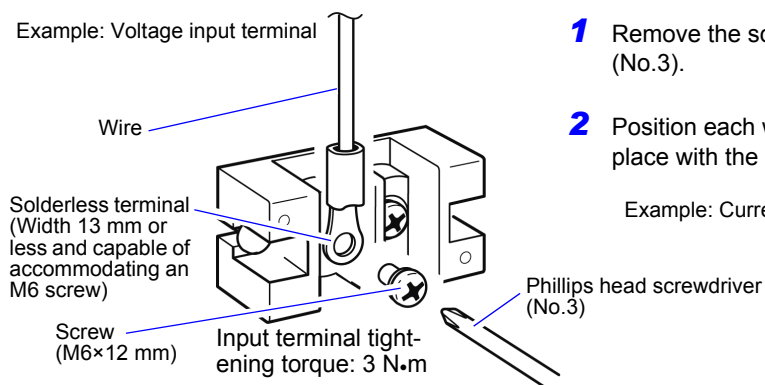

1 Remove the screws with the Phillips head screwdriver (No.3).

2 Position each wire as shown in the figure and secure in place with the screw. (M6×12 mm)

Example: Current input terminal

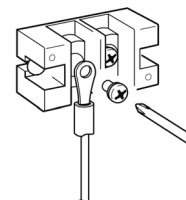

3 Attach the safety covers.

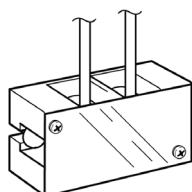

Attach each cover securely. (screws: M3×6 mm)

4 Connect the instrument to the measurement lines.

- 1** When measuring measurement lines that are within the maximum input range (voltage up to 1,000 V and current up to 30 A)

Connect the instrument to the measurement lines directly.

Instrument loss, which is caused by the input resistance of power measuring instruments' voltage and current inputs, increases with the input voltage and input current as well as with certain connection methods, and this in turn causes the error component of measured values to increase. Consequently, it is necessary to consider instrument error as one cause of inaccuracy in the power measured values required by standards such as IEC 62301:2011 (Household electrical appliance – Measurement of standby power). Calculate the instrument loss caused by the PW3335 based on the procedure described in "Example instrument loss calculation and connection method selection" (p.30) and choose the connection method that yields the least instrument loss.

Method 1: Connect the current input terminals to the load side.

Wiring diagrams

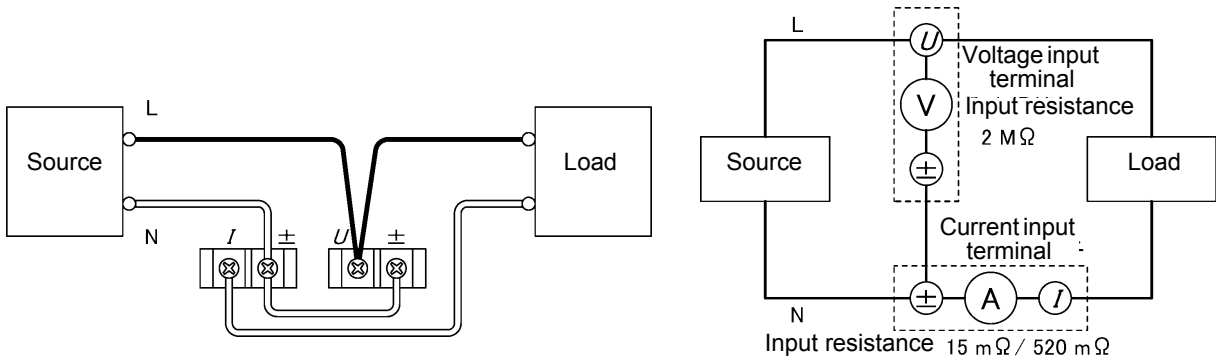

Method 2: Connect the voltage input terminals to the load side.

Wiring diagrams

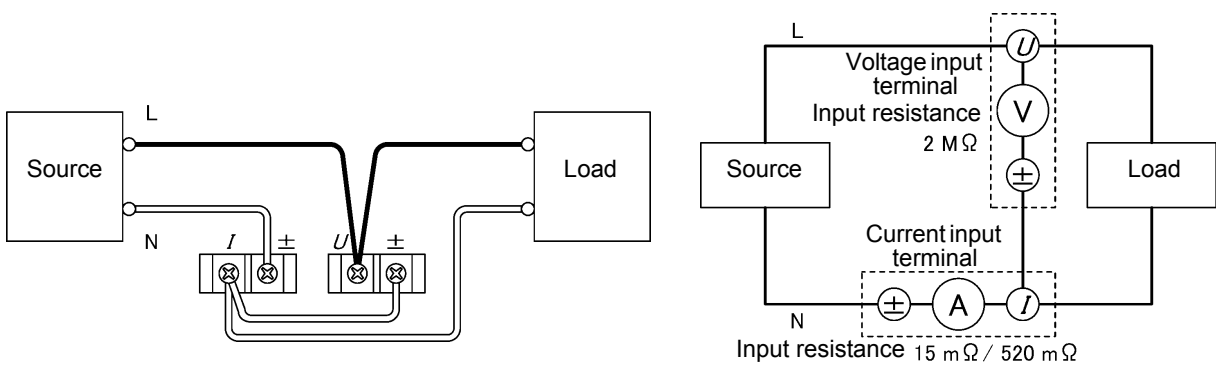

You can connect the instrument's current input terminals to the measurement line's L side (Hi side) as shown in the figure below and perform measurement using either Method 1 (connecting the current input terminals to the load side) or Method 2 (connecting the voltage input terminals to the load side), but these setups are susceptible to the effects of common-mode voltage. To reduce the effects of common-mode voltage, it is recommended to connect the current input terminals to the measurement line's N side (Lo side).

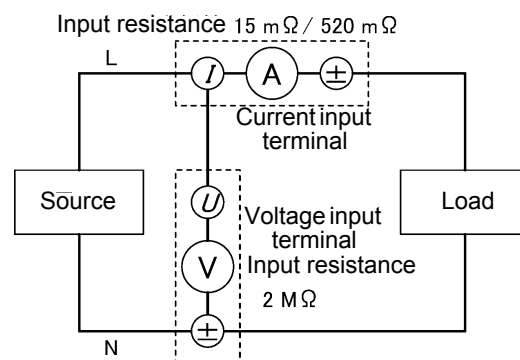
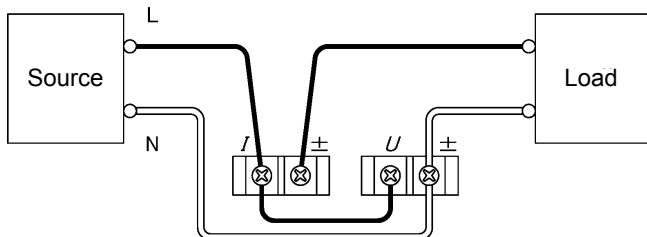
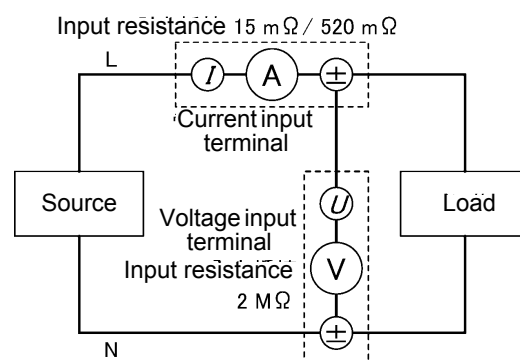
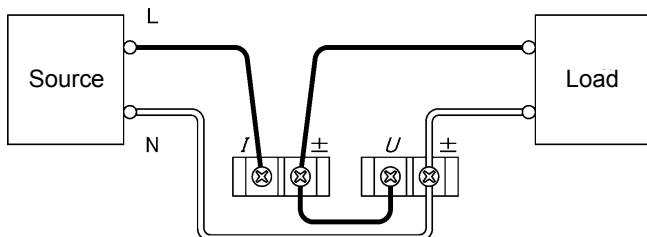
Method 1**Method 2**

2.2 Connecting the Measurement Lines

Example instrument loss calculation and connection method selection

The instrument's voltage input resistance and current input resistance are as follows:

Voltage input resistance: 2 MΩ ±0.04 kΩ (same for all ranges)

Current input resistance: For the 1 mA to 100 mA ranges, less than or equal to 520 mΩ

For the 200 mA to 20 A ranges, less than or equal to 15 mΩ

Depending on the magnitude of the input voltage and input current, instrument loss (loss caused by the input resistance of the voltage inputs and the input resistance of the current inputs) will affect measured values. Following are examples of how to calculate instrument loss for the PW3335 and an explanation of how to choose the connection method.

Method 1

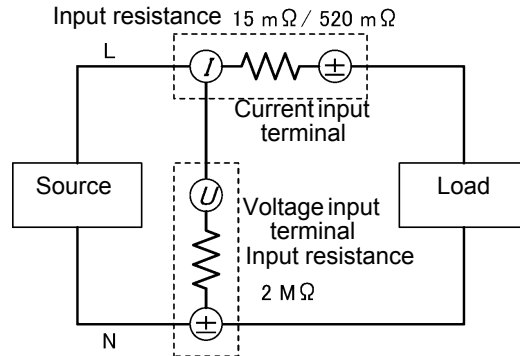
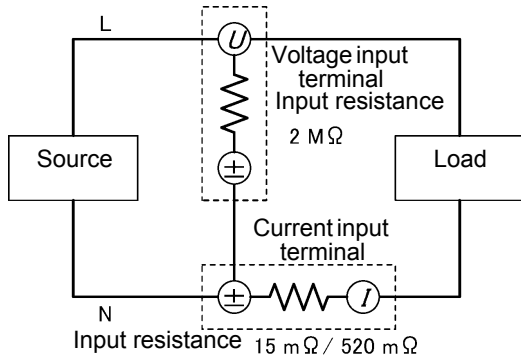

Method 2

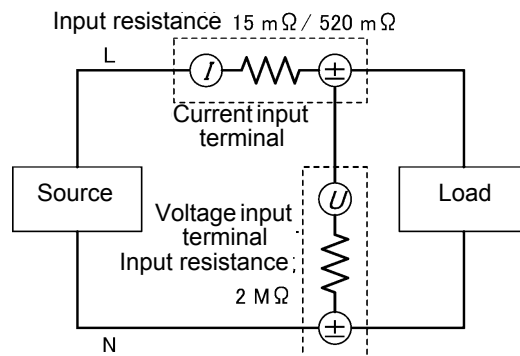
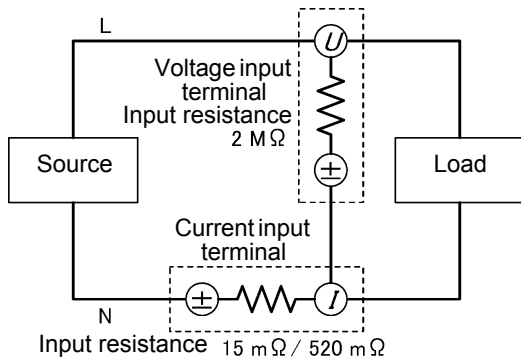

Example 1: Input voltage of 100 V, current of 8 mA, and active power of 0.08 W (power factor of 0.1)

Method 1:

With Method 1, instrument loss is caused by the current input resistance of the current inputs.

$$\text{Instrument loss} = (\text{Input current})^2 \times (\text{Current input resistance})$$

(1) Using the 10 mA range (with a current input resistance of 520 mΩ)

$$\text{Instrument loss} = (0.008 \text{ A})^2 \times 520 \text{ m}\Omega = 0.03328 \text{ mW}$$

(2) Using the 200 mA range (the range with the lowest current input resistance of 15 mΩ)

$$\text{Instrument loss} = (0.008 \text{ A})^2 \times 15 \text{ m}\Omega = 0.00096 \text{ mW}$$

Method 2:

With Method 2, instrument loss is caused by the voltage input resistance of the voltage inputs.

$$\begin{aligned} \text{Instrument loss} &= (\text{Input voltage})^2 \div (\text{Voltage input resistance}) \\ &= (100 \text{ V})^2 \div 2 \text{ M}\Omega = 5 \text{ mW} \end{aligned}$$

Connect the instrument using Method 1, which has the lower instrument loss. The instrument loss in this configuration is 0.03328 mW (while using the 10 mA range) or 0.00096 mW (while using the 200 mA range).

Although it is possible to measure a current of 8 mA with the 200 mA range, which has an effective measurement range of 2 mA to 300 mA, measurement accuracy will suffer. To make this measurement at a higher level of accuracy, use a lower range that does trigger a peak value overage (i.e., one for which the **PEAK OVER I** lamp does not light up).

Example 2: Input voltage of 3.3 V DC, current of 28 A DC, and active power of 92.4 W DC

Method 1:

Since the input current is 28 A DC, the 20 A range (with an effective measurement range of 0.2 A to 30 A) will be used.

$$\begin{aligned} \text{Instrument loss} &= (\text{Input current})^2 \times (\text{Current input resistance}) \\ &= (28 \text{ A})^2 \times 15 \text{ m}\Omega = 11.76 \text{ W} \end{aligned}$$

Method 2:

$$\begin{aligned} \text{Instrument loss} &= (\text{Input voltage})^2 \div (\text{Voltage input resistance}) \\ &= (3.3 \text{ V})^2 \div 2 \text{ M}\Omega = 0.000005445 \text{ W} \end{aligned}$$

Connect the instrument using Method 2, which has the lower instrument loss. The instrument loss in this configuration is 0.000005445 W.

The following figure provides some guidelines for choosing the connection method. The horizontal axis represents input current, and the vertical axis represents input voltage. The straight line on the graph indicates values for which the loss caused by the input resistance of the voltage inputs is equal to the loss caused by the input resistance of the current inputs. Using this line as a boundary, choose Method 1 when the input falls in the area above and to the left of the line, and choose Method 2 when the input falls in the area below and to the right of the line. For example, if the input voltage is 100 V, you would use an input current of 600 mA (in fact, 577.4 mA) as the boundary, choosing Method 1 for currents of less than approximately 600 mA and Method 2 for currents of greater than approximately 600 mA.

Current input resistance: 520 mΩ

Line at which voltage input loss equals current input loss (boundary line)

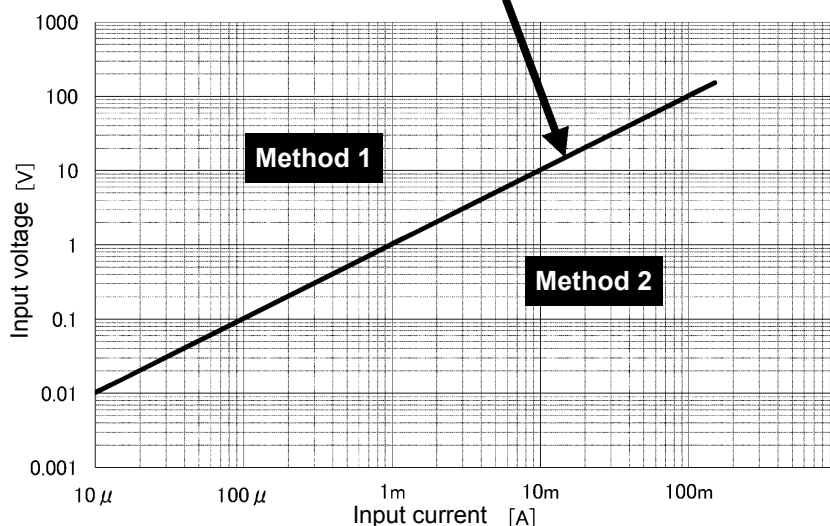
**Current input resistance: 15 mΩ**

Line at which voltage input loss equals current input loss (boundary line)

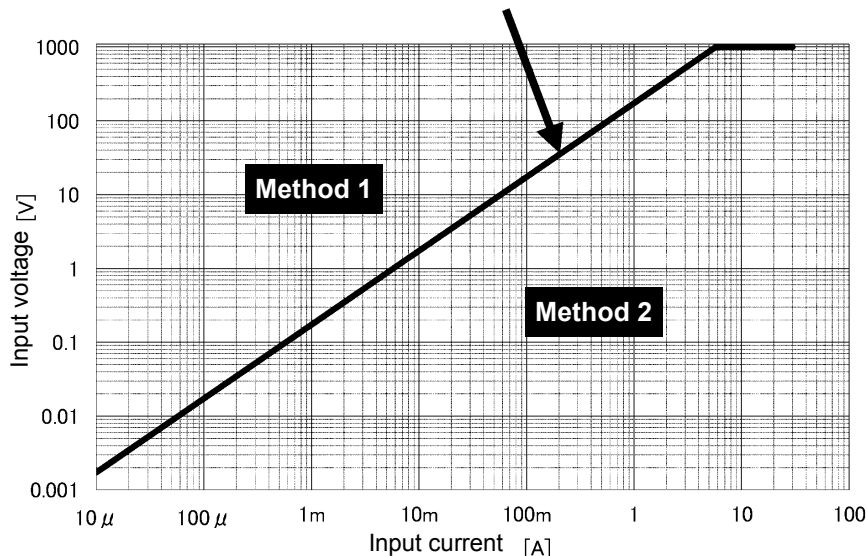

2.2 Connecting the Measurement Lines

2 When measuring measurement lines that exceed the maximum input voltage (1000 V) or maximum input current (30 A)

Connect the instrument using a VT (PT) and CT.

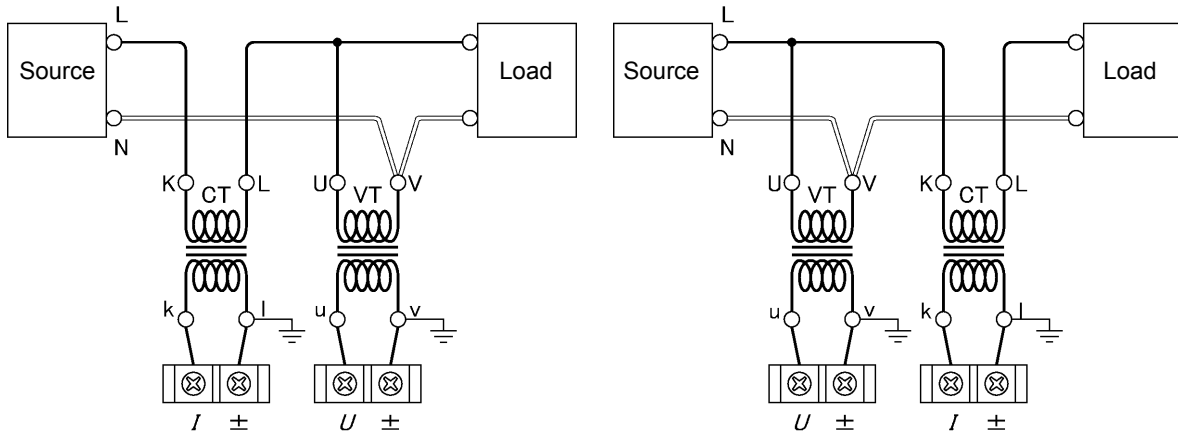

3 When measuring measurement lines that exceed the maximum input current (30 A)

Connect the instrument using a optional current sensor.
(PW3335-03 or PW3335-04 only)

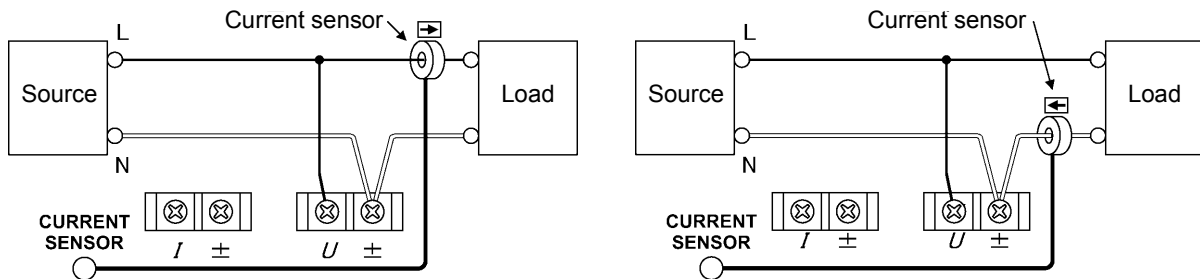

2.3 Connecting the Power Cord



- Before turning the instrument on, make sure the supply voltage matches that indicated on the its power inlet. Connection to an improper supply voltage may damage the instrument and present an electrical hazard.
Rated supply voltage: 100 V AC to 240 V AC, rated power supply frequency: 50 Hz/60 Hz
- To avoid electrical accidents and to maintain the safety specifications of this instrument, connect the power cord provided only to a 3-contact (two- conductor + ground) outlet.

Turn off the power before disconnecting the power cord.

Rear

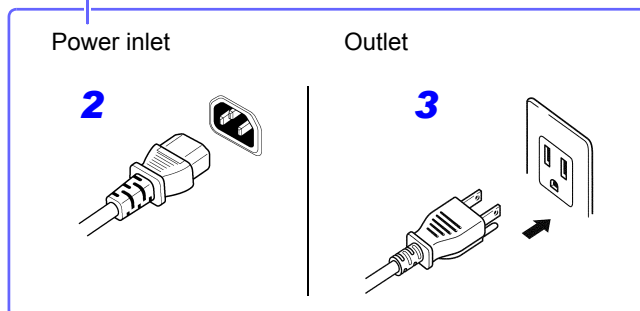
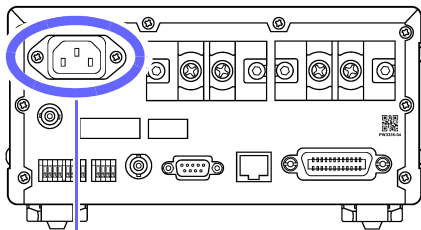

- 1** Check that the instrument's power is turned off.
- 2** Connect a power cord that matches the line voltage to the power inlet on the instrument.
- 3** Plug the other end of the power cord into an outlet.

2.4 Turning On the Instrument

Turn the POWER switch on (|).

When the instrument is turned on, it will start a self-test. During the self-test, all indicators will light up, and then the model and version number will be displayed. Finally, hardware and saved data will be checked.

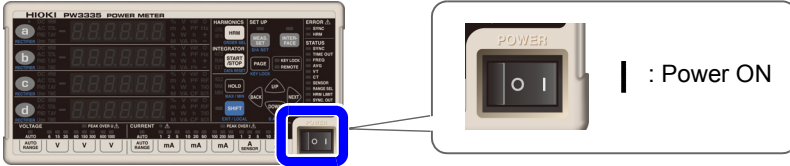

- Do not press any keys during the self-test.
- Key processing is embedded in the instrument for production and verification purposes. For example, this processing includes transitioning to an adjustment mode. If key operation causes a message or indication that is not described in this manual to be displayed, immediately cycle the instrument's power.

Self-test (example: PW3335-03)

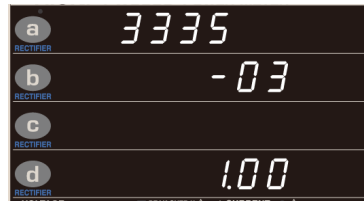
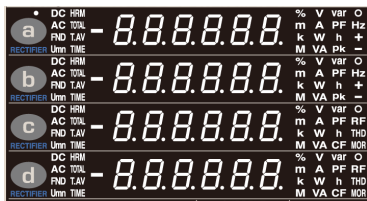

The product model and version number are displayed.



No errors

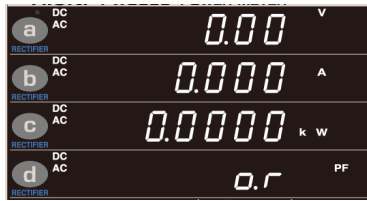

Normal display (Measurement screen)

Error (s)



Any errors are displayed.

See: "6.2 Error Indication"(p.170)

- The current settings when the instrument was last turned off will be restored the next time it is turned on (backup function).
If you're using the instrument for the first time, the default settings will be used. (p.111)
- To ensure good measurement precision, allow the instrument to warm up for at least 30 minutes after turning it on.

2.5 Performing Zero-adjustment

Zero-adjustment (offset adjustment) is performed for voltage and current measured values after the instrument has warmed up for approximately 30 minutes in order to ensure that its measurement accuracy specifications are satisfied. During zero-adjustment, the offsets of the instrument's voltage and current internal circuitry are adjusted.

Zero-adjustment should always be performed before starting measurement after the instrument has warmed up.

- Perform zero adjustment when there is no input to the instrument, after deactivating power to measurement lines. If zero-adjustment is performed while there is input to the instrument, the process will not complete normally, and you will be unable to make accurate measurements.
- Optional current sensors 9277, 9278, 9279, CT6841, and CT6843 are not degaussed. Degauss current sensors as described in the instruction manual that came with each current sensor before performing the instrument's zero-adjustment process.
- When using the CT6841/CT6843, perform zero-adjustment for the CT6841/CT6843 using the 1 A range noted on the panel.

Zero-adjustment adjusts offsets within the following ranges:

Voltage circuitry: $\pm 15\%$ of the measurement range

Current direct input circuitry: $\pm 15\%$ of the measurement range

External current sensor input circuitry: $\pm 15\%$ of the measurement range

Operating time: Approx. 30 sec. (No measured values are displayed during zero-adjustment.)

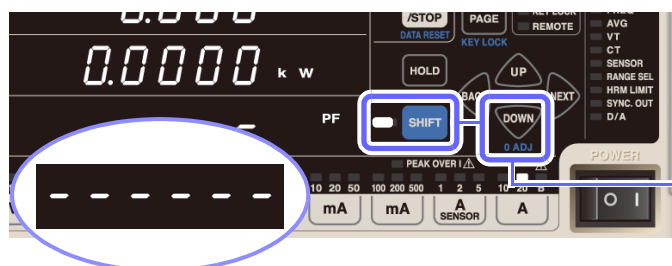

1 Deactivate power to measurement lines and ensure that no input is being supplied to the instrument.

2 Press **SHIFT** to place the instrument in the shift state and then press **DOWN**.

During zero-adjustment (approximately 30 sec.), [- - - - -] will be displayed.

Once zero-adjustment is complete, the instrument will change to the normal display (Measurement screen) and be ready for measurement.

- Zero-adjustment is performed for all voltage and current ranges, regardless of current input method.
- Settings cannot be changed, and integration cannot be started, during zero-adjustment.
- Zero-adjustment cannot be performed while integration is being performed or during display hold or maximum value/minimum value hold operation.
- To enable high-precision measurement, it is recommended to perform zero-adjustment at an ambient temperature that falls within the range specified in the specifications.
- Turn off power to the measurement lines and perform zero-adjustment with the instrument in the no-input state. The instrument will display [Err.18] if input is present when performing zero-adjustment. If this occurs, remove the input and then repeat the zero-adjustment process.

2.6 Activating Power to the Measurement Lines

Before activating power to the measurement lines



Before activating power to the measurement lines, turn on the instrument and verify that no errors are displayed.

If any measurement target lines are live before the instrument is turned on, the instrument may be damaged, or an error may be displayed when it is turned on.

See: "2.4 Turning On the Instrument"(p.34), "6.2 Error Indication"(p.170)

The instrument and input terminals may become hot when a large voltage or current is input.

2.7 Turning Off the Instrument

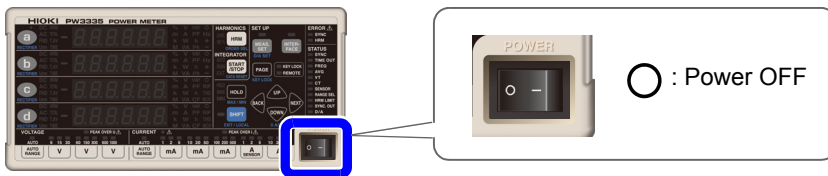

Once measurement is complete, turn the **POWER** switch off (○).

Disconnect the wires.

When power is turned on again, the instrument will start up with the settings that were in effect when it was turned off.



When the instrument is turned off, do not apply voltage or current to the instrument. Doing so may cause the instrument to become hot, resulting in burns or damage to the instrument.

- When the instrument is turned off, the input resistance of the current input terminals will be approximately 500 mΩ.
- If leaving the connections in place after measurement is complete, be sure to conduct a pre-measurement inspection (p.37) before making the next measurement. Such an inspection will enable you to prevent electric shock and measurement errors caused by breaks in cables, short-circuits, instrument failures, and other issues.

Configuration and Measurement

Chapter 3

Please read "Operating Precautions" (p.5) carefully before using the instrument.
For more information about the measurement process, see "1.4 Measurement Workflow" (p.20).

3.1 Pre-Measurement Inspection

Before using the instrument the first time, verify that it operates normally to ensure that no damage occurred during storage or shipping. If you find any damage, contact your authorized Hioki distributor or reseller.

1 Peripheral Device Inspection

When using connection cables

Is the insulation of the probe or connection cable to be used damaged, or is bare metal exposed?
Are any of the input terminal screws loose?

Metal Exposed?
Screws are loose.

If there is any damage or the screws are loose, there is a risk of electric shock or short-circuit. Do not use the instrument. Replace the probe or cable with an undamaged equivalent. Securely retighten screws. (p.27)

No Metal Exposed
Screws are tight.

2 Instrument Inspection

Is there any damage to the instrument?

Yes

If damage is evident, request repairs.

No

Turn on the instrument.

Is self-test information (model, version number) displayed?

No

There may be a break in the power cord, or there may be internal damage to the instrument.
If you find a break in the power cord, contact your authorized Hioki distributor or reseller to purchase the designated power cord as a replacement for the broken cord.
If the instrument is damaged, have it repaired.

Yes

Is the Measurement screen displayed after the self-test completes?

An error indication occurs (ERR)

The instrument may be damaged internally. Request repairs.
See: "6.2 Error Indication" (p.170)

Yes

Inspection complete

Allow the instrument to warm up for at least 30 minutes after turning it on.

Perform zero-adjustment.

Turn on power to the measurement lines.

No measured value is displayed.
Measured value error

There may be a break in a connection cable or internal damage to the instrument, or the instrument may have been connected improperly.
Immediately disconnect the measurement line power supply and repeat the inspection. If there is no problem with the wiring, have the instrument repaired.

3.2 Configuring Settings

3.2.1 Selecting the Current Input Method

PW3335-03

PW3335-04

This section describes how to select the current input method.

The instrument can perform measurement using the current input methods listed below.

The default setting is the current direct input method (setting: OFF).

WARNING



• The external current sensor input terminals are not isolated. You must connect an optional current sensor in order to use them.

• Inputting a voltage other than output from an optional current sensor or inputting a primary-side voltage may damage the instrument or cause electric shock, a short-circuit, or bodily injury.

CAUTION



When using external current sensor input terminals, disconnect all wiring from the current input terminals. Similarly, when using the current input terminals, disconnect all wiring from the external current sensor input terminals.

The current input method serves to switch the input signals to the instrument's internal circuitry. Improperly configuring the current input method will make it impossible to make accurate measurements.

■ Current direct input method

- Connect wires and input current directly to the current input terminals.
- The input terminals are isolated.
- The maximum input current is 30 A, ± 100 A peak.

■ External current sensor input method (p.100)

- Connect optional current sensors (voltage output) to the external current sensor input terminals to measure current.
- The input terminals are not isolated. Isolation is accomplished by the connected current sensors.
- The maximum input voltage for the external current sensor input terminals is 8 V, ± 12 V peak.
- TYPE.1 and TYPE.2 input is supported, depending on the current sensor specifications.

TYPE.1 current sensors (p.102)

These current sensors can be directly connected to the external current sensor input terminal.

- Model 9661 Clamp on Sensor (rated current: 500 A AC)
- Model 9669 Clamp on Sensor (rated current: 1000 A AC)
- Model 9660 Clamp on Sensor (rated current: 100 A AC)
- Model CT9667 Flexible Clamp on Sensor (rated current: 500 A / 5,000 A AC range switchable)

TYPE.2 current sensors (p.102)

Connecting these sensors to the external current sensor input terminal requires optional 9555-10 Sensor Unit and L9217 Connection Cord.

- Model 9272-10 Clamp on Sensor (rated current: 20 A / 200 A AC range switchable)
- Model 9277 Universal Clamp on CT (rated current: 20 A AC/DC)
- Model 9278 Universal Clamp on CT (rated current: 200 A AC/DC)
- Model 9279 Universal Clamp on CT (rated current: 500 A AC/DC)
- Model 9709 AC/DC Current Sensor (rated current: 500 A AC/DC)
- Model CT6862 AC/DC Current Sensor (rated current: 50 A AC/DC)
- Model CT6863 AC/DC Current Sensor (rated current: 200 A AC/DC)
- Model CT6865 AC/DC Current Sensor (rated current: 1000 A AC/DC)
- Model CT6841 AC/DC Current Probe (rated current: 20 A AC/DC)
- Model CT6843 AC/DC Current Probe (rated current: 200 A AC/DC)



1 Press **MEAS. SET**.



2 Press **PAGE** to switch to the current input settings screen. ([SEnSor] will be displayed in display area c.)



3 Press **BACK** or **NEXT** until the display area d flashes.

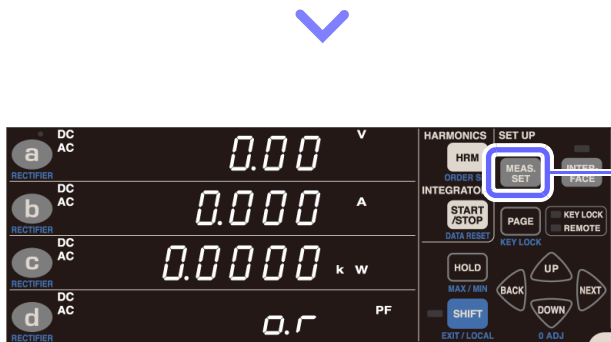

4 Press **UP** or **DOWN** to set the current input method.

Default setting: OFF

Settings: **oFF** (direct input) → **tyPE.1** → **tyPE.2** ...

(When set to TYPE.1 or TYPE.2, the **SENSOR** lamp will light up.)

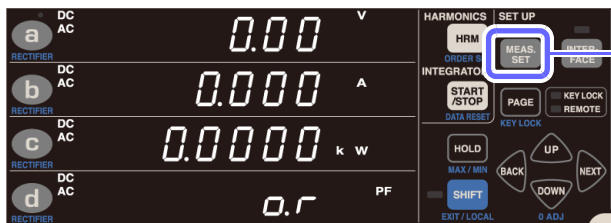

5 Press **MEAS. SET** to exit the settings.

The instrument will return to the normal display (Measurement screen).

- The current input method cannot be changed while integration is being performed or during display hold or maximum value/ minimum value display hold operation.
- Auto-range integration mode cannot be used when the current input method is set to TYPE.1 or TYPE.2.

3.2.2 Selecting Display Content

This section describes how to select the information shown on the instrument's display.

- Selecting display parameters
- Selecting rectifiers (p.42)

See: "Appendix 1 Detailed Specifications of Measurement Items (Display Items)" (p. A1)

Default settings

- a**: Voltage (V), AC+DC
- b**: Current (A), AC+DC
- c**: Active power (W), AC+DC
- d**: Power factor (PF), AC+DC

Selecting display parameters

This section describes how to select the parameters that are shown on the instrument's display.

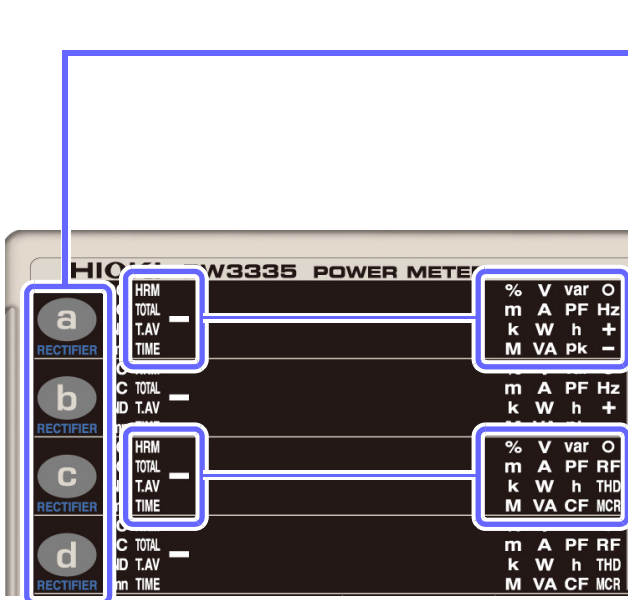

Every time **a**, **b**, **c**, **d**, or **NEXT** is pressed, the each relevant display is switched in the following order.

(Pressing **BACK** will reverse the order.)

a, **b**
V → **A** → **W** → **VA** → **var** → **PF** → **°** → **VHz** → **AHz**
 → **Vpk** → **Apk** → **T.AV-A** → **T.AV-W** → **Ah+** → **Ah-**
 → **Ah** → **Wh+** → **Wh-** → **Wh** → **TIME** →
TOTAL T.AV-A → **TOTAL T.AV-W** → **TOTAL Ah+** →
TOTAL Ah- → **TOTAL Ah** → **TOTAL Wh+** →
TOTAL Wh- → **TOTAL Wh** → **TOTAL TIME** → **V** ...

c, **d**
V → **A** → **W** → **VA** → **var** → **PF** → **°** → **RF-V %** →
RF-A % → **THD-V %** → **THD-A %** → **CF-V** → **CF-A**
 → **MCR** → **T.AV-A** → **T.AV-W** → **Ah** → **Wh** → **TIME**
 → **TOTAL T.AV-A** → **TOTAL T.AV-W** → **TOTAL Ah**
 → **TOTAL Wh** → **TOTAL TIME** → **V** ...

- The voltage and current are displayed from 0.5% to 152% of the range.
(When input is less than 0.5% of the range, zero-suppression forces a value of zero to be displayed.)
- Active power is displayed from 0% to 231.04% of the range.
(There is no zero-suppression function.)
- Depending on the rectifier, certain display parameters cannot be measured. In this case, the display will show [- - - -].
See: "Appendix 1 Detailed Specifications of Measurement Items (Display Items)" (p. A1)
- The polarity symbol at the power factor indicates whether the current waveform lags or leads the voltage waveform.
Symbol [None]: Current waveform lags voltage waveform
Symbol [-]: Current waveform leads voltage waveform
This symbol is linked to those at the reactive power and phase angle. However, if an input level of the voltage or current is 20% or less of the corresponding ranges, an incorrect polarity symbol may be displayed.

If a warning lamp or “o.r” is displayed

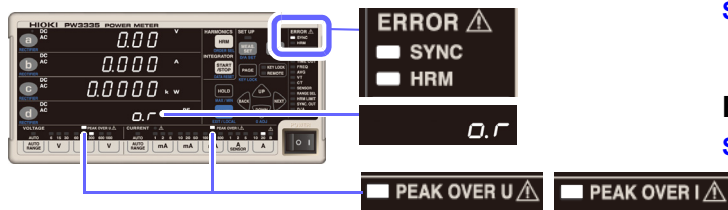

ERROR ⚠ SYNC

See: "3.2.5 Setting the Frequency Measurement Range (Zero-cross filter)" (p.50)

ERROR ⚠ HRM

See: "3.4.4 About the HRM ERROR lamp" (p.77)

PEAK OVER, o.r

See: "3.10 When warning lamp, o.r, or the Unit Indicator Flashes" (p.112)

Selecting the rectifier

The instrument provides the five rectifiers listed below. Since data for all rectifiers is processed in parallel internally, the rectifier can be switched during measurement.

1. **DC AC** Displays true RMS values for DC only, AC only, or mixed DC and AC voltage and current.
2. **DC AC U_{mn}** Displays mean value rectified RMS equivalents for DC only, AC only, or mixed DC and AC voltage. Current values are displayed as RMS values.
3. **DC** Displays simple average values (DC components only) for voltage and current. The calculated value (voltage DC value) × (current DC value) is displayed as the DC component for active power.
4. **AC** Displays calculated values given by the following equation as RMS values for the AC component only for voltage and current:

$$\sqrt{(AC+DC \text{ value})^2 - (DC \text{ value})^2}$$
 The calculated value given by (active power AC+DC value) - (active power DC value) is displayed as the active power value for the AC component only.
5. **FND** Extracts and displays the fundamental wave component only using harmonic measurement.

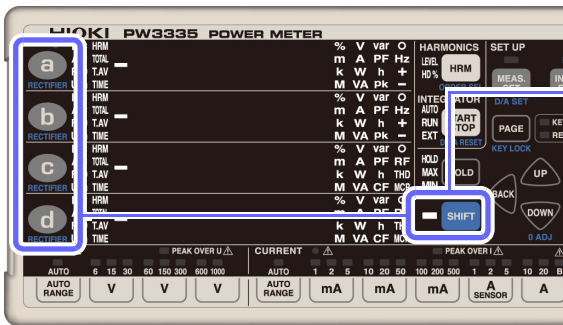

Default setting: AC+DC

Every time **a**, **b**, **c**, or **d** is pressed after pressing **SHIFT** to activate the shift state, the display will change as follows:

AC+DC → AC+DC U_{mn} → DC → AC → FND → AC+DC ...

The shift state is canceled approx. 2 seconds after **a**, **b**, **c**, or **d** is released.

You can also select the rectifier by pressing **UP** or **DOWN**. (Pressing **UP** will reverse the order.)

Use **DOWN** after canceling the shift state so that zero-adjustment is not performed.

- When the DC rectifier is selected, the voltage (*U*) and current (*I*) polarity will also be displayed (as a simple average).
- When the AC+DC or AC rectifier is selected, the voltage and current display values will always be positive.
- Depending on the rectifier, certain display parameters cannot be measured. In this case, the display will show [- - - -].

3.2.3 Selecting the Voltage and Current Ranges



When input exceeds 1,000 V, $\pm 1,500$ V peak, or 30 A, ± 100 A peak

The maximum input voltage and maximum input current are 1,000 V, $\pm 1,500$ V peak, and 30 A, ± 100 A peak. If the maximum input voltage or maximum input current is exceeded, immediately halt measurement, deactivate power to the measurement lines, and disconnect the cables from the instrument. Continuing measurement with maximum input exceeded will damage the instrument and cause bodily injury.



Do not input a voltage or current in excess of each measurement range. Doing so will damage the instrument.

See: "3.10.1 If the PEAK OVER U or PEAK OVER I Lamp Lights Up" (p.112)
"3.10.3 When o.r (over-range) Is Displayed" (p.113)

Selecting the desired range

Press the range key to select the desired range. The lamp for the selected range key will light up, and the display value will change to reflect the selected range.

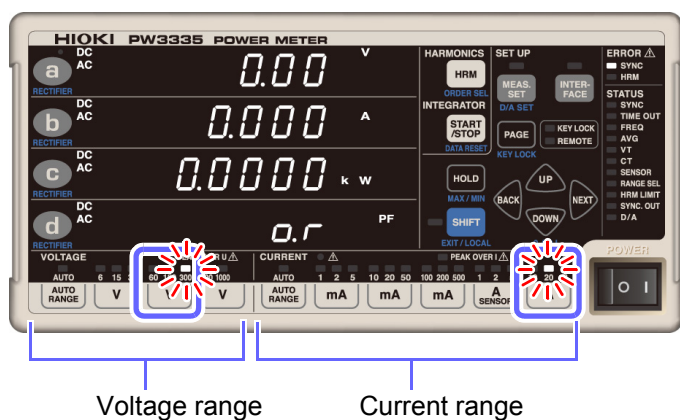

Default settings: 300 V voltage
20 A current

Two or three ranges are assigned to each range key.

- Allow the following amount of time to elapse before reading measured values after changing the range:
 - When the frequency of input set to the synchronization source is 10 Hz or greater
Approx. 0.6 sec.
 - When the frequency of input set to the synchronization source is less than 10 Hz
- **See:** "3.2.6 Setting the Timeout" (p.54)
- If the range changes, the invalid data display [- - - -] will be shown until the data is updated.
- When measuring frequencies of 10 Hz or less, it is necessary to set the timeout to a value other than 0.1 sec.
- **See:** "3.2.6 Setting the Timeout" (p.54)
- When using external current sensor input (TYPE.1 or TYPE.2) as the current input method, only  is valid for selecting the current range. Pressing another range key will cause [tyPE.1] or [tyPE.2], indicating the type of external current sensor, to be displayed, and the range will not be changed.
- Ranges cannot be changed while integration is being performed or during display hold operation.

Automatically setting the range (auto-range operation)

Selecting auto-range operation causes the range to be switched automatically according to the measured value. This feature is convenient when you do not know the optimal range.

■ Setting auto-range operation

See: "Auto-range operation" (p.45)

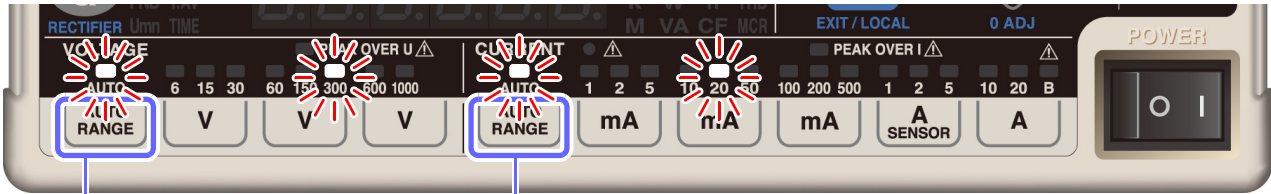

- 1** Press **AUTO RANGE** for the voltage range or current range.
- 2** The **AUTO** lamp and the lamp for the range being measured will light up.

■ Canceling auto-range operation

Press any range key or press **AUTO RANGE** again.

- When the measurement range is set to auto-range operation, the output rate for level and waveform output for D/A output will vary with the range. When measuring lines for which measured values fluctuate excessively, exercise care so as not to mistake range conversions. It is recommended to use a fixed range for this type of measurement.
- Voltage and current are displayed from 0.5% to 152% of the range.
- Active power is displayed from 0% to 231.04% of the range.
- Display range values have an error of ± 1 dgt. due to calculation precision.
- When integration is started using auto-range integration, voltage auto-range operation will be canceled, and the range at that point will be fixed. When integration is started using fixed-range integration, voltage and current auto-range operation will be canceled, and the ranges at that point will be fixed.
- Ranges cannot be changed during display hold operation.

Auto-range operation

During auto-range operation, the range is switched as described below:

Range increased	Range decreased
<ul style="list-style-type: none"> When the measured value exceeds 150% of the range When the PEAK OVER lamp lights up 	When the measured value is less than 15% of the range, the range will be switched to the optimal range. (The range will not be decreased when the value would exceed the peak value for the next lower range.*)

* Example:

Assume that the input current changes to an RMS value of 10 mA and the current waveform peak value changes to 400 mA while using the 100 mA range. Since 15% of the 100 mA range is 15 mA, this RMS value should cause the range to be lowered. However, since the current waveform peak value is 400 mA, a peak overage would occur with the 50 mA range. In this case, the range will not be lowered from the 100 mA range.

The voltage and current display range is $\pm 0.5\%$ to $\pm 152\%$ of the range.

When the measured value is less than $\pm 0.5\%$ of the range, the zero-suppression function forces the value to be displayed as zero.

When **Err. 12** or **Err. 16** is displayed

These errors indicate that the instrument was unable to switch ranges. Take the following action to address the error:

Error display	Status	Solution and reference for more information
Err. 12	During integration operation (RUN lamp lit up or flashing)	The range cannot be switched until the integrated value is reset (so that the RUN lamp turns off). See: "Canceling integration (resetting integrated values) (DATA RESET)" (p.65)
Err. 16	During display hold operation (HOLD lamp lit up)	The range cannot be switched until the display hold is canceled (so that the HOLD lamp turns off). See: "Canceling the display hold state" (p.106)

Skipping unnecessary ranges (range select function)

Because the instrument provides a large number of ranges (8 voltage ranges and 14 current ranges), range switching can be time-consuming, particularly during auto-range operation. If you know which ranges you will be using before you begin and wish to switch ranges more quickly, you can use the range select function. The PW3335's range select function makes it possible to limit range switching to a smaller pool of necessary ranges by letting you enable the ranges you wish to use and disable the ranges you do not wish to use (i.e., the ranges you wish to skip).

The 1,000 V range, 100 mA range, 20 A range, and 5 A range noted on the external current sensor panel (E.5) cannot be disabled (skipped).

Range selection

Operation	Setting	ON (use)	OFF (do not use)
Range selection with range keys		Yes	No
Range switching with auto-range operation		Yes	No (skipped)
Range switching with auto-range integration		Yes	No (skipped)

If any range has been disabled (set to OFF), the **RANGE SEL** lamp will light up. (Default state: All ranges are enabled [ON].)

- 1 Press **MEAS. SET**.
- 2 Press **PAGE** to switch to the range select settings screen. (**rAnGE**) will be displayed in display area **a**.)
- 3 Press **BACK** or **NEXT** until the display area **b** flashes.
- 4 Press **UP** or **DOWN** to display the range to enable or disable (the range you wish to select). The range will flash.



- 5** Press **BACK** or **NEXT** until the display area **c** flashes.

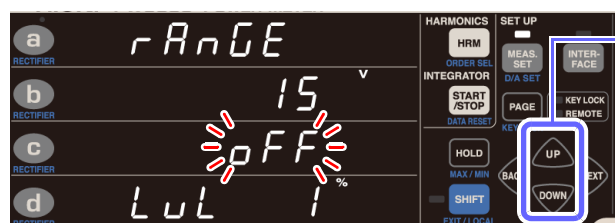

- 6** Press **UP** or **DOWN** to set ON or OFF.

Default setting: ON

Settings: **on** → **oFF** → **on** ...

(The lamp for the range that was disabled will turn off.)

- 7** If there are other ranges you wish to select, repeat steps **3** through **6**.



- 8** Press **MEAS. SET** to exit the settings.

The instrument will return to the normal display (Measurement screen).

3.2.4 Setting the Synchronization Source (SYNC)

This section describes how to set the synchronization source used to determine the cycle (between zero-cross events) that will be used as the basis for calculations.

You can select from the following parameters: U, I, DC (fixed at 200 ms)

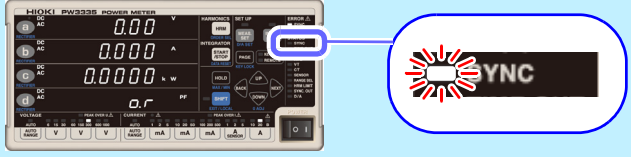

When the synchronization source is set to I or DC, the **SYNC** lamp will light up. When set to the voltage U, the **SYNC** lamp will not light up.



1 Press **MEAS. SET**.

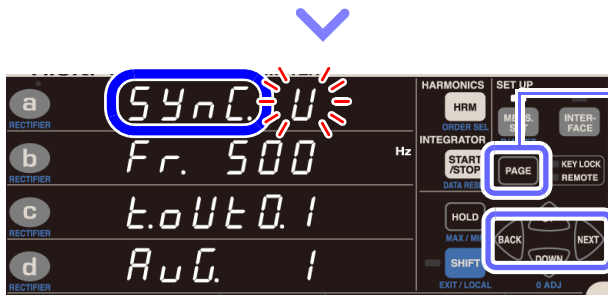

2 Press **PAGE** to switch to the synchronization source settings screen. ([Sync.] will be displayed in display area a.)

3 Press **BACK** or **NEXT** until the display area **a** flashes.



4 Press **UP** or **DOWN** to set the synchronization source.

Default setting: U
Settings: U → i → dC → U ...

(Setting the source to I or DC will cause the **SYNC** lamp to light up.)

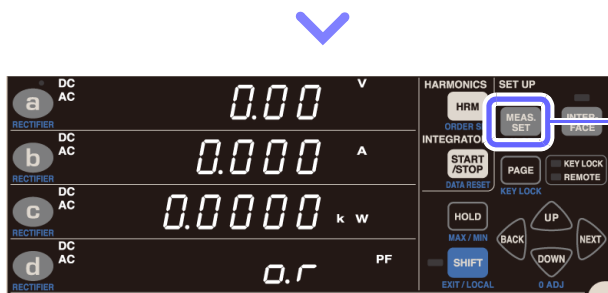

5 Press **MEAS. SET** to exit the settings.

The instrument will return to the normal display (Measurement screen).

- Setting the synchronization source to DC when using AC input will cause display values to fluctuate, preventing accurate measurement. Set the synchronization source to a value other than DC when using AC input.
- Input for the parameters selected as synchronization sources must be at least 1% of the range.
- When the **SYNC** lamp (ERROR) is lit up, accurate measurement cannot be performed.
- Even when the **SYNC** lamp (ERROR) is not lit up, accurate measurement cannot be performed if the synchronization source input signal is in any of the following states:
 1. When a signal with a frequency higher than the frequency measurement range (zero-cross filter) is being input
 2. When a measured voltage or current of an AC component of an input signal is less than 1% of each relevant range.
 3. When a measured voltage or current of an AC component of an input signal is greater than 150% of each relevant range.
 4. When a signal with a frequency component within the frequency measurement range (zero-cross filter) other than the measurement signal's fundamental wave frequency is superposed
Example: When the frequency measurement range (zero-cross filter) is 500 Hz, if a signal for which zero-crosses occur at a frequency of less than 500 Hz (a modulation signal, noise, etc.) is input on top of a 50 Hz input signal
- The synchronization source cannot be changed while integration is being performed or during display hold or maximum value/ minimum value display hold operation.

3.2.5 Setting the Frequency Measurement Range (Zero-cross filter)

If the **SYNC** lamp (ERROR) lights up, change the zero-cross filter setting.

When the synchronization source is set to voltage (U) or current (I), the **SYNC** lamp (ERROR) will light up if the synchronization signal cannot be acquired. When the **SYNC** lamp (ERROR) is lit up, the instrument will not be able to perform accurate measurement.

The instrument incorporates 100 Hz, 500 Hz, 5 kHz, and 100 kHz low-pass filters for use in switching the cut-off frequency (i.e., as a zero-cross filter). These filters also vary with the frequency measurement range.

Additionally, accurate measurement also cannot be performed when using input of a low frequency of less than 10 Hz (with a repeating period of greater than 0.1 sec.) because each input cycle will exceed the instrument's calculation processing interval (causing a timeout). The **SYNC** lamp (ERROR) will also light up at this time. In this case, set the instrument's timeout setting to 1 sec. (for an input frequency of less than 10 Hz) or 10 sec. (for an input frequency of less than 1 Hz). (p.54)



Accurate measurement cannot be performed if the **SYNC** lamp (ERROR) is lit up.

Setting the timeout to 1 sec. to 10 sec. will cause the **TIME OUT** lamp to light up. The default value is 0.1 sec.

The zero-cross filter is linked to the frequency measurement range. If you are unable to perform frequency measurement, change this zero-cross filter setting. The default setting is 500 Hz. Setting it to 100 Hz, 5 kHz, or 200 kHz will cause the **FREQ** lamp to light up.

Setting	Description	FREQ lamp
100 Hz	Use this setting primarily when measuring standard AC power supply equipment (50 Hz, 60 Hz) and when using the fundamental wave (100 Hz or less) on the secondary side of an inverter as the synchronization signal.	on
500 Hz (Default setting)	Use this setting primarily when measuring standard AC power supply equipment (50 Hz, 60 Hz, 400 Hz) and when using the fundamental wave on the secondary side of an inverter as the synchronization signal.	off
5 kHz	Use this setting when using frequency input in excess of 500 Hz as the synchronization signal.	on
100 kHz	Use this setting when using frequency input in excess of 5 kHz as the synchronization signal.	on



1 Press MEAS. SET





2 Press **PAGE** to switch to the zero-cross filter settings screen. ([Fr.] will be displayed in display area b.)

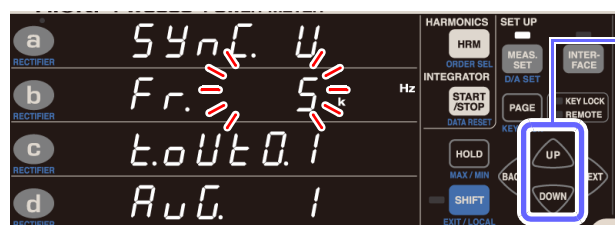

3 Press **BACK** or **NEXT** until the display area **b** flashes.

4 Press **UP** or **DOWN** to set the zero-cross filter (100 Hz/ 500 Hz/ 5 kHz/ 100 kHz).

Default setting: 500 Hz

Settings: **500** → **5k** → **100k** → **100** → **500** ...



5 Press **MEAS. SET** to exit the settings.

The instrument will return to the normal display (Measurement screen).

Display of frequency measurements (Displayed as V Hz or A Hz on panel display)

From 0.1000 Hz to 9.9999 Hz



From 10 Hz to 99.999 Hz



From 100 Hz to 999.99 Hz



From 1 kHz to 9.9999 kHz



From 10 kHz to 99.999 kHz



100 kHz



Because measured values become difficult to read near the point at which the display switches, the resolution is lowered by one digit.

Example: If the frequency being measured changes from 1 kHz to 999 Hz, the display resolution for 1 kHz to 9.9999 kHz measurement will remain in effect, and the value will be displayed as 0.9990 kHz. If the frequency being measured then changes again to a value that is less than or equal to 990 Hz, the instrument will switch to the display resolution for 100 Hz to 999.99 Hz and display the value as 990.00 Hz.

See: Frequency Measurement Specifications (p.146)

- When measuring an AC signal with a frequency lower than 500 Hz, it is recommended to set the frequency measurement range (zero-cross filter) to 100 Hz or 500 Hz to reduce the noise component at 500 Hz and higher. Select the frequency measurement range depending on frequencies of signals to be measured.
- Frequency measurement accuracy is guaranteed for sine wave input that is at least 20% of the frequency measurement source's measurement range. The instrument may not be able to perform frequency measurement accurately for other inputs (when the measurement signal is distorted, when there is a superposed noise component, etc.).
- The frequency measurement range cannot be changed while integration is being performed or during display hold or maximum value/minimum value hold operation.
- If a frequency of a signal to be measured is above the selected frequency measurement range, the instrument may not be able to perform frequency measurement accurately. Change the frequency measurement range to an appropriate one.
(Example) If a signal with a frequency above 500 Hz is input into the instrument with the frequency measurement range that is set to 500 Hz, change the frequency measurement range to 5 kHz or higher.

Significance of changing the zero-cross threshold level

The PW3335 calculates parameters such as RMS values and active power based on one cycle of the synchronization source's input waveform (voltage U or current I). This cycle is obtained by detecting the zero-cross interval (the interval from one rising edge until the next cycle's rising edge). Consequently, waveform distortion due to a cause such as zero-cross noise near the rising edge of the input waveform set as the synchronization source can cause detection of a zero-cross other than actual input waveform cycle, compromising the instrument's ability to make accurate measurements. The PW3335 provides the function for setting a threshold value used to judge zero-cross events caused by noise to be false, ignoring them. This threshold value can be set in the range between 1% (default) and 15% of each measurement range, and is applied to both the positive and negative sides. Once a zero-cross event is detected, the subsequent zero-cross events will be ignored unless the input waveform goes across the upper or lower threshold value.

If zero-cross events are excessively detected due to input waveform distortion, the frequency is inaccurately measured. In that case, adjust the threshold level.

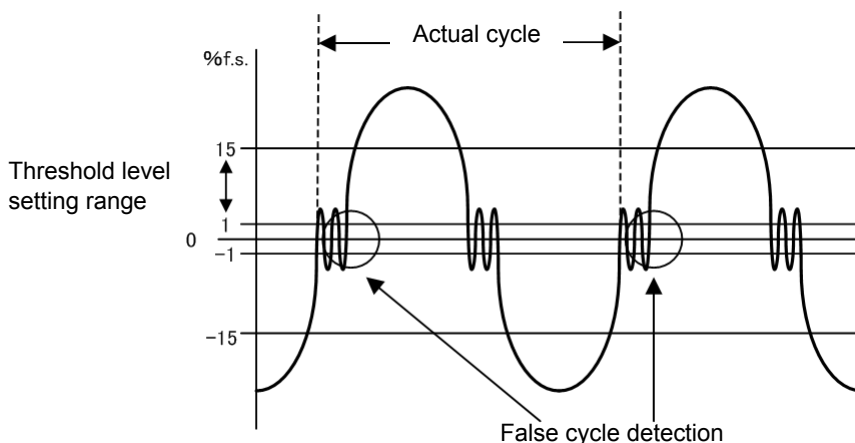

If the measurement of frequency is not performed accurately, neither does the correct detection of phase shift between the voltage and current, the power factor or the reactive power are indicated inaccurately, and the polarity of phase angle incorrectly.

Setting the zero-cross filter's threshold level



- 1 Press **MEAS. SET**.
- 2 Press **PAGE** to switch to the zero-cross filter's threshold level settings screen. ([rAnGE] will be displayed in display area a.)
- 3 Press **BACK** or **NEXT** until the display area **b** flashes.
- 4 Press **UP** or **DOWN** to display the range to set (it will flash).
- 5 Press **BACK** or **NEXT** until the display area **d** flashes.
- 6 Press **UP** or **DOWN** to set the zero-cross filter's threshold level (%).
 Default setting: 1
 Settings: **1 to 15**
 (Setting any of the zero-cross filter threshold levels to a value other than the default value will cause the **RANGE SEL** lamp to light up.)
- 7 Press **MEAS. SET** to exit the settings.
 The instrument will return to the normal display (Measurement screen).

3.2.6 Setting the Timeout

Accurate measurement cannot be performed when using input of a low frequency of less than 10 Hz (with a repeating period of greater than 0.1 sec.) because each input cycle will exceed the instrument's calculation processing interval (causing a timeout). The **SYNC** lamp (ERROR) will light up at this time. In this case, set the instrument's timeout setting to 1 sec. (for an input frequency of less than 10 Hz) or 10 sec. (for an input frequency of less than 1 Hz).



Accurate measurement cannot be performed if the **SYNC** lamp (ERROR) is lit up.

Setting the timeout to 1 sec. to 10 sec. will cause the lamp to light up. The default value is 0.1 sec.

Setting	Description	TIME OUT lamp
0.1 sec. (Default setting)	Use this setting when the frequency of the input set as the synchronization source is 10 Hz or higher.	off
1 sec.	Use this setting when the frequency of the input set as the synchronization source is less than 10 Hz.	on
10 sec.	Use this setting when the frequency of the input set as the synchronization source is less than 1 Hz.	on

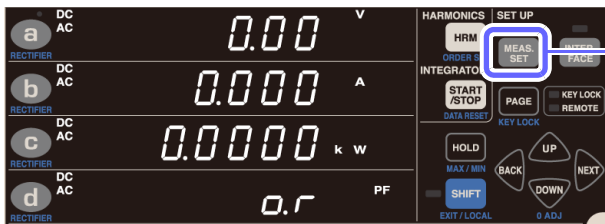

1 Press **MEAS. SET**.

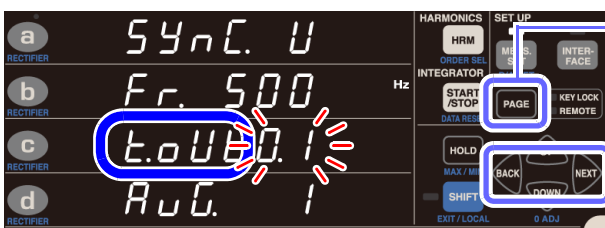

2 Press **PAGE** to switch to the timeout settings screen. ([t.oUt] will be displayed in display area c.)

3 Press **BACK** or **NEXT** until the display area **c** flashes.



4 Press **UP** or **DOWN** to set the timeout (0.1 sec., 1 sec., or 10 sec.).

Default setting: 0.1 sec.

Settings: **0.1** → **1** → **10** → **0.1** ...

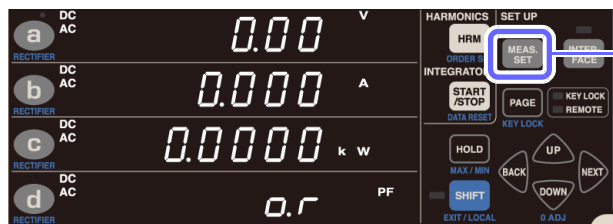

5 Press **MEAS. SET** to exit the settings.

The instrument will return to the normal display (Measurement screen).

- When the frequency of the input to the set synchronization source is less than 5 Hz, the data update (display update) timing will vary with the frequency of the input to the synchronization source.
Example: If the frequency of the input to the synchronization source is 0.8 Hz, the data (display) will be updated every $1/0.8 = 1.25$ sec.
- If the **SYNC** lamp (ERROR) lights up when the timeout has been set to a value other than 0.1 sec., the display will be updated once every time the timeout set time elapses.
- The timeout setting cannot be changed while integration is being performed or during display hold or maximum value/minimum value hold operation.
- The instrument is equipped with the high-pass filters to avoid influences from DC components of input signals during detecting cycles. Because the time constants of the high-pass filters are linked to the timeout settings, if the range is changed, or an input voltage or current including a DC component rapidly changes, it will take a time until the measured value stabilizes.
Please wait and read the measured value after the following time. The required time varies depending on the timeout setting.
 - When the timeout is set to 0.1 sec.: approximately 0.6 sec.
 - When the timeout is set to 1 sec.: approximately 10 sec.
 - When the timeout is set to 10 sec.: approximately 40 sec.

3.2.7 Displaying Measured Values as an Average (AVG: Averaging)

In averaging operation, the number of averaging iterations for measured values is set, and averaged data is displayed. Used when measured values fluctuate, causing excessive variation in the display, this setting provides a way to reduce variation in display values.

The instrument uses simple averaging to average measured values. The display update interval varies with the number of averaging iterations setting.

$$\text{Average value} = \frac{\sum_{k=1}^n Xk}{n}$$

Xk: Measured value every 200 ms (instrument display update rate)
n: Number of averaging iterations

Number of averaging iterations and display update interval

Number of averaging iterations	1 (OFF)	2	5	10	25	50	100
Display update interval	200 msec.	400 msec.	1 sec.	2 sec.	5 sec.	10 sec.	20 sec.

Parameters that are averaged

The five parameters of voltage, current, active power, apparent power, and reactive power are averaged, while the power factor and phase angle are calculated from averaged data.

Parameters that are not averaged

Voltage frequency, current frequency, current integration, active power integration, integration time, voltage waveform peak value, current waveform peak value, voltage crest factor, current crest factor, time average current, time average active power, voltage ripple rate, current ripple rate, maximum current ratio, all harmonic measurement parameters

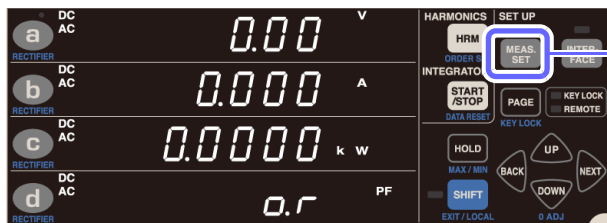

1 Press **MEAS. SET**.

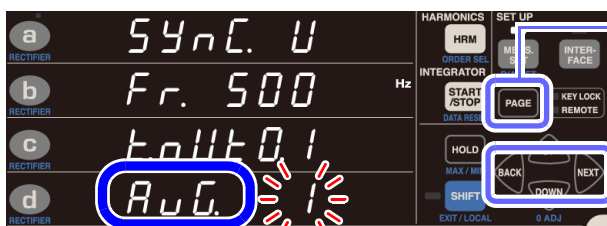

2 Press **PAGE** to switch to the timeout settings screen. ([AVG.] will be displayed in display area d.)

3 Press **BACK** or **NEXT** until the display area d flashes.

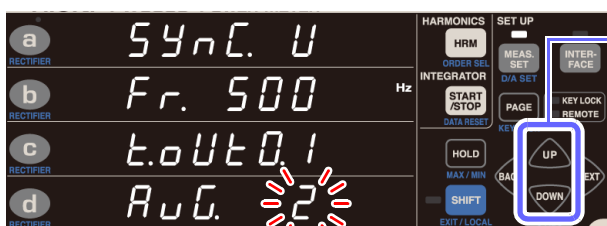

4 Press **UP** or **DOWN** to set the number of averaging iterations.

When the setting is changed to a value other than the default setting of 1, the **AVG** lamp will light up.

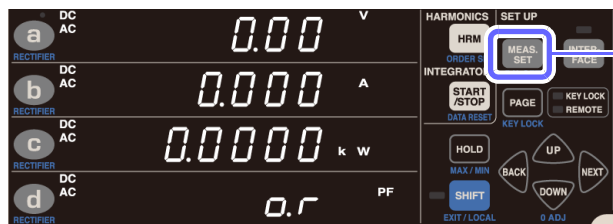

5 Press **MEAS. SET** to exit the settings.

The instrument will return to the normal display (Measurement screen).

- Averaging will restart when there is a change that affects measured values, for example in the range, number of averaging iterations, current input method, VT ratio, or CT ratio. Since no average value exists immediately after the start of averaging, the invalid data display [-----] will be shown. During this period of time, the **AVG** lamp will flash.
- If the instantaneous value changes to [o.r] while average values are being displayed, the display will change to [o.r].
- The unit may flash during measurement.
See: "3.10.4 When the Unit Indicator Flashes" (p.114)
- Averaging processing is performed for voltage, current, active power, apparent power, and reactive power.
- The power factor and phase angle are calculated from the averaged active power and apparent power.

If the number of average iterations does not flash

This indicates that the number of averaging iterations cannot be changed.

After pressing **MEAS. SET** to exit the setting, perform the following procedure:

Status	Solution and reference for more information
During integration operation (RUN lamp lit up or flashing)	Averaging cannot be changed until the integrated value is reset (so that the RUN lamp turns off). See: "Canceling integration (resetting integrated values) (DATA RESET)" (p.65)
During display hold operation or maximum value/minimum value hold operation (HOLD , MIN , or MAX lamp lit up)	Averaging cannot be changed until this operation is canceled (so that the HOLD lamp turns off). See: "Canceling the display hold state" (p.106) "Switching the display among the maximum, minimum, and instantaneous values" (p.107)

3.2.8 Setting the VT Ratio and CT Ratio

When inputting a voltage in excess of the instrument's maximum input voltage of 1,000 V or a current in excess of its maximum input current of 30 A, use an external VT (PT) or CT, respectively. This section describes how to set the ratio (VT ratio or CT ratio) when using an external VT or CT. Even when using an external current sensor, it is necessary to set the CT ratio.

By setting the VT ratio and CT ratio, you can read the measured current value (CT primary-side current) directly.



WARNING When the VT and CT lamps are lit up (particularly when the VT ratio and CT ratio are set to values less than 1), a voltage or current greater than the displayed measured value may have been input to the instrument. To prevent an electrical accident or short-circuit, do not unnecessarily touch the instrument's input terminal or the measurement lines.

VT ratio setting range

0.001 to 0.009, 0.010 to 0.099, 0.100 to 0.999, 1.000 to 9.999, 10.00 to 99.99, 100.0 to 999.9 (1,000)

(If the VT ratio is set to 0.0, 00.0, or 000.0, the instrument internally multiplies measured values by a VT ratio of 1,000.)

CT ratio setting range

0.001 to 0.009, 0.010 to 0.099, 0.100 to 0.999, 1.000 to 9.999, 10.00 to 99.99, 100.0 to 999.9 (1,000)

(If the CT ratio is set to 0.0, 00.0, or 000.0, the instrument internally multiplies measured values by a CT ratio of 1,000.)

If the VT ratio or CT ratio does not flash

This indicates that the VT or CT ratio cannot be changed.

After pressing  to exit the setting, perform the following procedure:

Status	Solution and reference for more information
During integration operation (RUN lamp lit up or flashing)	The VT and CT ratios cannot be changed until the integrated value is reset (so that the RUN lamp turns off). See: "Canceling integration (resetting integrated values) (DATA RESET)" (p.65)
During display hold operation or maximum value/minimum value hold operation (HOLD , MIN , or MAX lamp lit up)	The VT and CT ratios cannot be changed until this operation is canceled (so that the HOLD lamp turns off). See: "Canceling the display hold state" (p.106) "Switching the display among the maximum, minimum, and instantaneous values" (p.107)

Setting the VT ratio

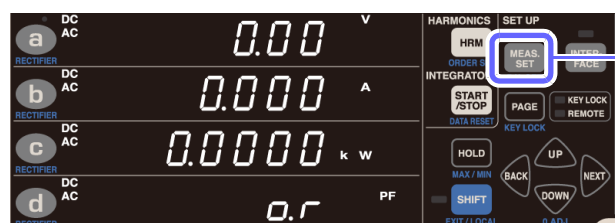

1 Press **MEAS. SET**.

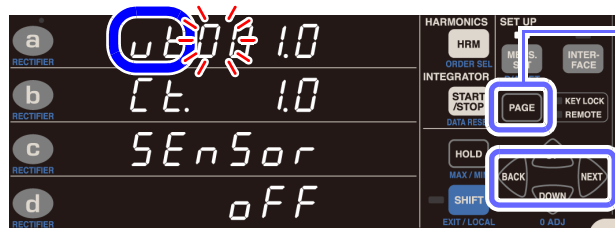

2 Press **PAGE** to switch to the VT ratio settings screen. ([vt.] will be displayed in display area a.)

3 Press **BACK** or **NEXT** until the digit you wish to set in display area a, which will start flashing.



4 Press **UP** or **DOWN** to set the VT ratio.

To move the decimal point:

Press **BACK** or **NEXT** until the decimal point flashes, and press **UP** or **DOWN**.

Default setting: 1.0

Setting range:

See: "VT ratio setting range" (p.58)



5 Press **MEAS. SET** to exit the settings.

The instrument will return to the normal display (Measurement screen).

Setting the CT ratio



1 Press **MEAS. SET**.

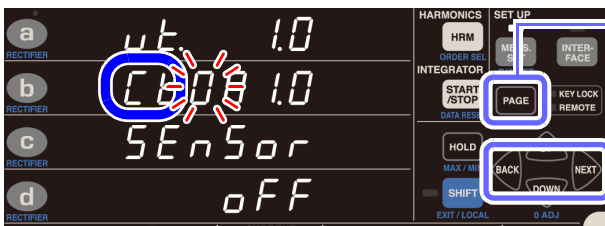

2 Press **PAGE** to switch to the VT ratio settings screen. ([Ct.] will be displayed in display area b.)



3 Press **BACK** or **NEXT** until the digit you wish to set in display area b, which will start flashing.

4 Press **UP** or **DOWN** to set the CT ratio.

To move the decimal point:

Press **BACK** or **NEXT** until the decimal point flashes, and press **UP** or **DOWN**.

Default setting: 1.0

Setting range:

See: "CT ratio setting range" (p.58)



5 Press **MEAS. SET** to exit the settings.

The instrument will return to the normal display (Measurement screen).

3.3 Integration

The PW3335's integration function can operate in either of two modes: fixed-range integration mode or auto-range integration mode.

Fixed-range integration mode

Integration operation uses the set measurement range. (When auto-range operation is enabled, integration is fixed to the range in effect at the start of operation.)

Auto-range integration mode

Integration operation is performed while the measurement range is controlled through auto-range operation. In this mode, the voltage range is fixed at the start of integration, but the current range is determined using auto-range operation between the 200 mA range and the 20 A range. This capability allows auto-range operation to be used in applications characterized by large changes in current or power, for example when measuring the sequence of operations of a household electronic device as it switches from the standby state to the normal operating state. Additionally, since not only the last integrated value, but also integrated values for each range that was used during integration operation can be displayed when integration is in the stopped state, operators can assess integrated values for each state of the measurement target (for example, standby and normal operation) after a single integration measurement session. Furthermore, auto-range integration can be used in combination with the range select function to shorten the switching time between ranges, allowing more efficient integration measurement.

Measurement range (Voltage: 150 V)		Example variations in integrated values and ranges used during active power integration	Active power integration display value
Current	Power		
B	3 kW		0.12562 Wh
20 A	3 kW		889.216 Wh
10 A Range select OFF	1.5 kW		0.00000 Wh
5 A Range select ON	750 W		246.325 Wh
2 A Range select OFF	300 W		0.00000 Wh
1 A Range select ON	150 W		23.6477 Wh
500 mA Range select ON	75 W		2.42385 Wh
200 mA Range select ON	30 W		0.82532 Wh
Total integrated value			

↑ Integration start ← When switching ranges ↑ Integration stop

3.3 Integration

The instrument performs integration for the current and active power in the positive direction (Ah+, Wh+), in the negative direction (Ah-, Wh-), and as sums (Ah, Wh) simultaneously and can display the integrated value for each. Integration can be started and stopped, and the integrated value can be reset, using either the instrument's keys or the external control function. Additionally, by setting the integration time, it is possible to perform timer integration in 1-minute units from 1 minute to 10,000 hours (approximately 417 days). Furthermore, it is also possible to display the time average current and time average active power as calculated from the integrated value at that point in time and the integration elapsed time while integration is being performed.

Measured values are integrated as valid data while they fall within the effective measurement range for integration; that is, the integration operation maintains until a peak of measurement values reaches the maximum effective peak voltage or maximum effective peak current (until the **PEAK OVER U** or **PEAK OVER I** lamp lights up).

Maximum effective peak voltage: $\pm 600\%$ of the voltage range (up to $\pm 1,500$ V peak for the 300 V, 600 V, and 1,000 V ranges)

Maximum effective peak current: $\pm 600\%$ of the current range (up to ± 100 A peak for the 20 A range)

Example: When performing DC current integration using the 1 A range, the current display value (A) will change to [o.r] when 1.52 A is exceeded, but the effective measurement range for current integration (Ah) extends from ± 10 mA (1% of the 1 A range) to ± 6 A, so the values will be integrated as valid data.

Display parameters and descriptions related to integration

Display parameter	Description
Ah +	Positive current integrated value
Ah -	Negative current integrated value
Ah	Sum of current integrated values
Wh +	Positive active power integrated value
Wh -	Negative active power integrated value
Wh	Sum of active power integrated values
TIME	Integration elapsed time
T.AV A	Time average current (obtained by dividing the sum of current integrated values by the integration elapsed time)
T.AV W	Time average active power (obtained by dividing the sum of active power integrated values by the integration elapsed time)

Displaying the rectifier and integrated values

Internally, the following integrated values are all integrated simultaneously, regardless of the rectifier. Consequently, integrated value data with simultaneity can be obtained simply by switching the display parameter.

Current (Ah+, Ah-, Ah)

Rectifier	Integration operation and display
AC+DC AC+DC Umn	The results of integrating current RMS value data (display values) once every display update interval (200 ms) are displayed as integrated values.
DC	The results of integrating sampled instantaneous data separately by polarity are displayed as integrated values.
AC, FND	[- - - -] (no integrated data) is shown.

Active power (Wh +, Wh -, Wh)

Rectifier	Integration operation and display
AC+DC AC+DC Umn	The results of integrating active power values calculated once for every cycle of the selected synchronization source separately by polarity are displayed as integrated values. This rectifier is used to integrate active power values of cyclic waveforms.
DC	The results of integrating sampled instantaneous data separately by polarity are displayed as integrated values. This rectifier is used to integrate active power values of non-cyclic waveforms such as a DC or others. (When a waveform to be measured includes both a DC and an AC component, the integrated value will not be an integration of only a DC component.)
AC, FND	[- - - -] (no integrated data) is shown.

Displayed integrated values

●: Displayed -: Displays [- - - -]

Rectifier	Ah+	Ah-	Ah	Wh+	Wh-	Wh	T.AV A	T.AV W
AC+DC, AC+DC Umn	-	-	●*	●	●	●	●*	●
DC	●	●	●	●	●	●	●	●

* During auto-range integration mode operation, triggers the invalid data ([- - - -]) display.

The display will indicate invalid data [- - - -] if no integrated value exists.

Display method



Press **a** through **d** to select the display parameter.

See: "3.2.2 Selecting Display Content" (p.40)

Display of integration elapsed time

From 0 sec. to 99 hr. 59 min. 59 sec.



From 100 hr. to 999 hr. 59 min.



From 1,000 hr. to 9,999 hr. 59 min.



10,000 hr.



Method for starting and stopping integration and resetting integrated values

The following four methods are used to start and stop integration and reset integrated values:

- Using **START/STOP**
- Using **communications** (see the Communications Command Instruction Manual)
- Using **external control** (p.82)
- Using **synchronized control** (p.78)

This section describes use of **START/STOP**.

For more information about integration using communications, external control, or synchronized control, refer to each section indicated above.

Starting integration

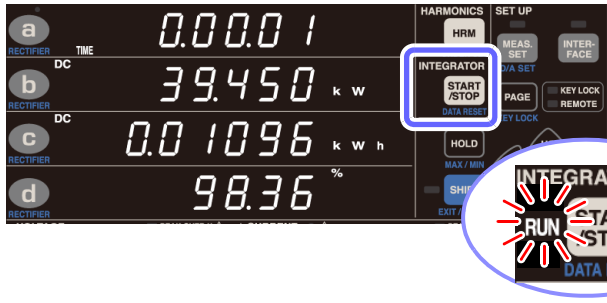

- 1 Verify that the instrument is in the integration reset state (**RUN** and **EXT** lamps off).
- 2 Press **START/STOP**.

Integration will start, and the **RUN** lamp will light up.

Stopping integration

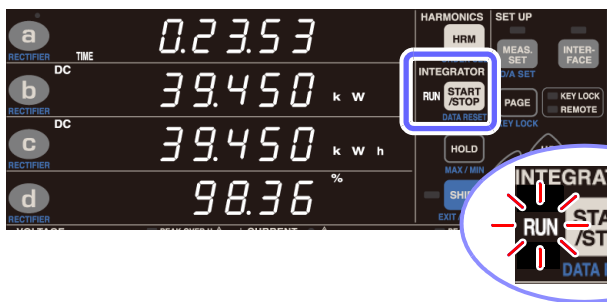

Press **START/STOP** while the **RUN** lamp is lit up (indicating that the instrument is performing integration).

Integration will stop, and the **RUN** lamp will flash.

Starting integration while adding to previous integrated values (additional integration)

Pressing **START/STOP** while the **RUN** lamp is flashing (indicating that integration is stopped) causes integration to start while adding to previous integrated values.

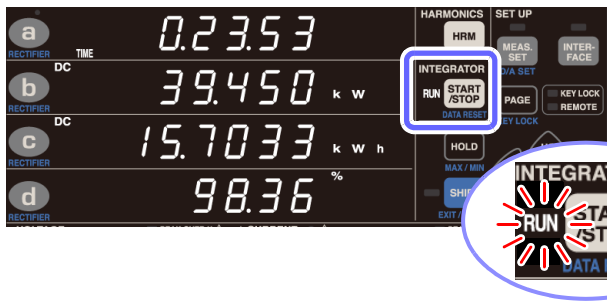

Press **START/STOP** while the **RUN** lamp is flashing.

Additional integration will start, and the **RUN** lamp will light up.

As long as the integrated values are not reset, additional integration is repeated.

Canceling integration (resetting integrated values) (DATA RESET)

Settings cannot be changed while integration is being performed (while the **RUN** lamp is lit up or flashing). To cancel integration, use the following procedure. When integration is canceled, measurement results up to that point will be reset.

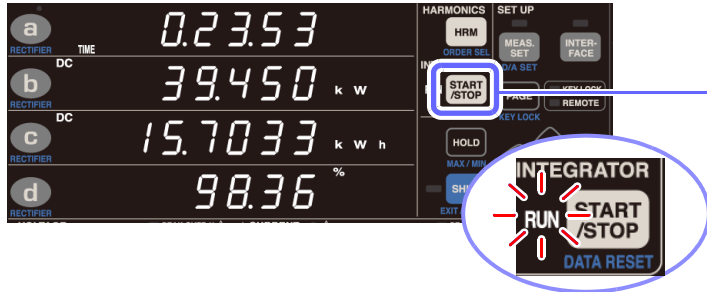

1 Press **START /STOP** to stop integration.

Integration will stop, and the **RUN** lamp will flash.

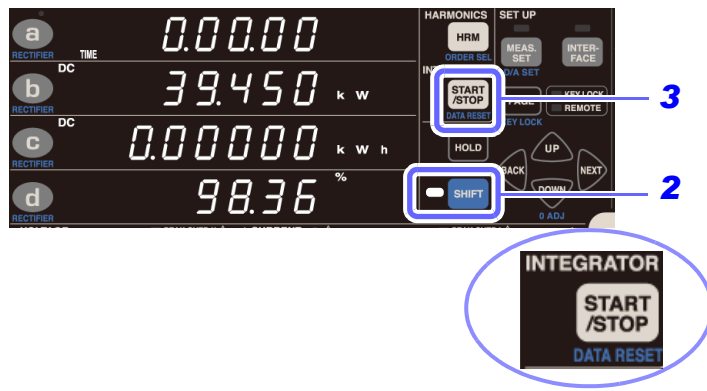

2 Press **SHIFT** to place the instrument in the shift state.

3 Press **START /STOP**.

Integrated values will be reset, and the **RUN** lamp will turn off.

Performing integration after setting an integration time (timer integration)

If an integration time has been set, integration is performed for the set period of time only. (Integration is stopped once the set period of time has elapsed.)

The instrument allows the integration time to be set in 1-minute increments from 1 minute to 10,000 hours. If using additional integration, operation will stop once the set time has elapsed after starting additional integration.



Example integration time setting displays

Integration time	Setting display
1 min.	0000.01
59 min.	0000.59
1 hr. 8 min.	0001.08
9,999 hr. 59 min.	9999.59
10,000 hr. (Default setting)	0000.00

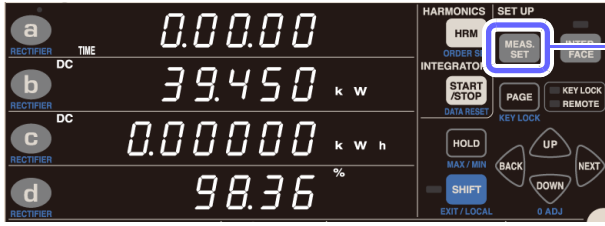

1 Press **MEAS. SET**.

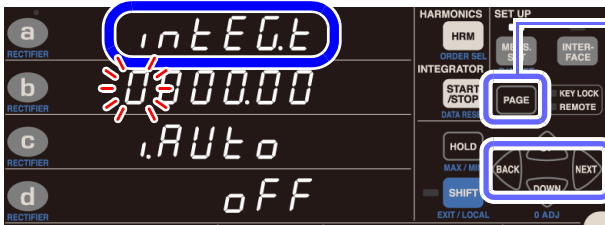

2 Press **PAGE** to switch to the integration time settings screen. ([intEG.t] will be displayed in display area a.)

3 Press **BACK** or **NEXT** until the digit you wish to set in display area b, which will start flashing.



4 Press **UP** or **DOWN** to set the integration time.

Default setting: 0000.00 (10,000 hours)

Setting range: **0000.00** to **9999.59**

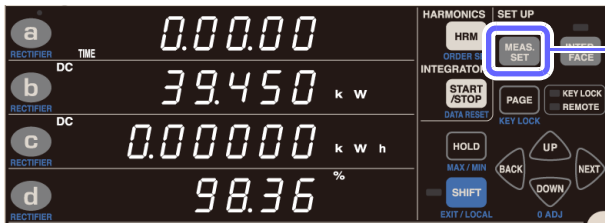

5 Press **MEAS. SET** to exit the settings.

The instrument will return to the normal display (Measurement screen).

If the integration time does not flash

This indicates that the integration time cannot be changed.

After pressing **MEAS. SET** to exit the setting, perform the following procedure:

Status	Solution and reference for more information
During integration operation (RUN lamp lit up or flashing)	The integration time cannot be changed until the integrated value is reset (so that the RUN lamp turns off). See: "Canceling integration (resetting integrated values) (DATA RESET)" (p.65)
During display hold operation or maximum value/minimum value hold operation (HOLD , MIN , or MAX lamp lit up)	The integration time cannot be changed until this operation is canceled (so that the HOLD lamp turns off). See: "Canceling the display hold state" (p.106) "Switching the display among the maximum, minimum, and instantaneous values" (p.107)

Enabling auto-range integration

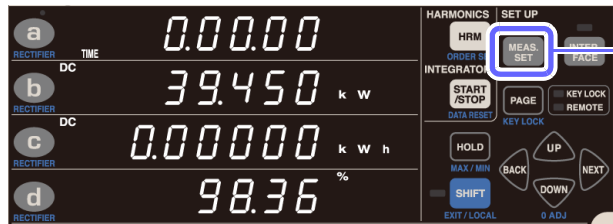

1 Press **MEAS. SET**.



2 Press **PAGE** to switch to the current input settings screen. ([i.AUto] will be displayed in display area c.)

3 Press **BACK** or **NEXT** until the display area d flashes.

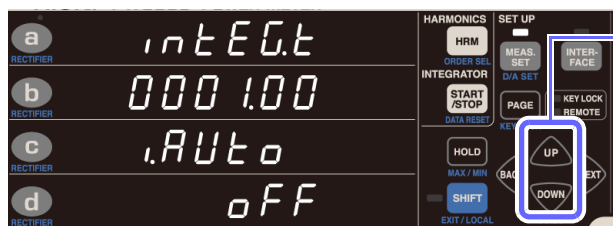

4 Press **UP** or **DOWN** to set ON (enable) or OFF (disable).

Default setting: OFF
Setting range: **OFF** → **on** → **OFF** ...

(Once auto-range integration has been enabled, the **AUTO** lamp to the left of **START/STOP** will light up.

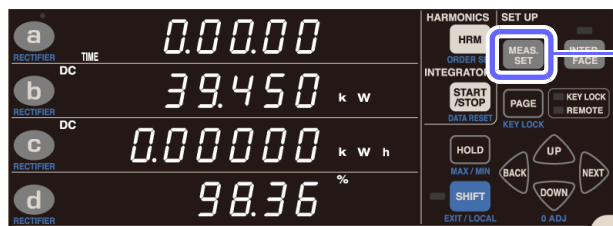

5 Press **MEAS. SET** to exit the settings.

The instrument will return to the normal display (Measurement screen).

If the current input method is set to TYPE.1 or TYPE.2, the AUTO lamp will not light up, and auto-range integration mode will not function.

Starting and stopping auto-range integration

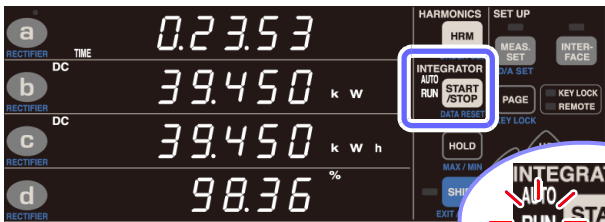
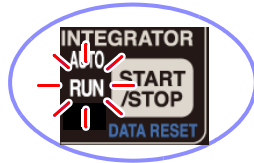
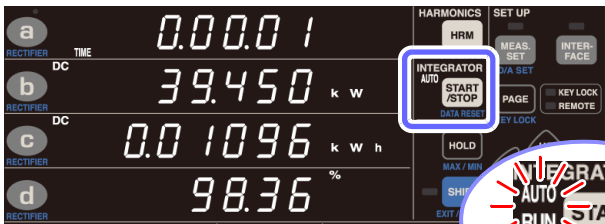

- 1 Press **START/STOP** when the **AUTO** lamp to the left of **START/STOP** is lit up.

Auto-range integration will start, and the **RUN** lamp will light up.

When auto-range integration starts, the current will switch to auto-range operation, and the range will vary between the 200 mA range and the 20 A range.

Integration operation will automatically stop once the set integration time has elapsed, and the **RUN** lamp will start flashing.

- 2 Integration operation can also be stopped by pressing **START/STOP**.

Auto-range integration will stop, and the **RUN** lamp will flash.

- 3 Press **START/STOP** again to restart integration.

RUN lamp will light up.

Supplemental explanation

- (1) When integration starts, the voltage range is fixed.
- (2) The timeout duration changes to 0.1 sec.
- (3) The current range cannot be changed while auto-range operation is in progress. Once integration has stopped, the current range can be changed, and integrated values for the 200 mA range to the 20 A range and the B range can be displayed.
- (4) When the **TOTAL** lamp is lit up on the integration display, the following data is shown in auto-range integration mode:
 - Sum of integrated values for all ranges
 - Sum of integrated times for all ranges
 - Time-averaged value for overall range
- (5) Functionality linked to auto-range integration
 - Maximum and minimum value detection is cleared and restarted when integration starts. Additionally, maximum and minimum value detection is stopped when integration stops. (This operation is the same as for normal integration.)
 - When auto-range integration is enabled, options for the current range you wish to output (200 mA to 20 A, B, total) are shown in the time-average (**T.AV**) and integrated value (**Ah**, **Wh**) fields on the D/A output settings screen.
 - If a power failure occurs during integration, integration will be in the stopped state when power to the instrument is restored. Although integrated values are backed up, the data for maximum and minimum values is cleared, triggering the invalid data display. (This operation is the same as for normal integration.)
 - Some settings cannot be changed while integration is in progress or while integration is stopped. (This operation is the same as for normal integration.)

Integration precautions

- (1) When integration starts with the 20 A fixed range, the voltage and current auto-range setting will be canceled, and measurement will be fixed to the range in effect when integration started. Set the range so that the **PEAK OVER U** (overvoltage input alarm) lamp and **PEAK OVER I** (overcurrent input alarm) lamp do not light up during integration.
If the **PEAK OVER U** lamp or **PEAK OVER I** lamp lights up during integration, the integrated value will not be accurate. In this case, the Ah or Wh unit will flash until integrated values are reset (DATA RESET). (Even if the current or active power measured value is [o.r] [over-range], measured values falling within the range such that the **PEAK OVER U** and **PEAK OVER I** lamps do not light up will be integrated.)
- (2) Equipment constraints due to the integration
Some parameters cannot be set or changed in the integration state (when the **RUN** lamp is lit up) or in the integration stopped state (when the **RUN** lamp is flashing). If a change is not supported, [Err.12] will be displayed for approximately 1 second.
See: Constraints during integration operation (p.148)
- (3) If an integrated value reaches 999,999 MWh, or if the integration elapsed time reaches 10,000 hours, integration will stop, and you will not be able to restart it. ([Err.14] will be displayed for approximately 1 second.) In this case, restart integration after pressing the **SHIFT** followed by the **START/STOP** to reset integrated values (causing the **RUN** lamp to turn off).
See: "Canceling integration (resetting integrated values) (DATA RESET)" (p.65)
- (4) Maximum value and minimum value measurement will also restart when integration starts. If an integration reset is performed, maximum value and minimum value measurement will also restart. Averaging will also restart when integration is reset.
- (5) When a system reset is performed, integration operation will stop, and the instrument will revert to its factory settings.
See: "3.9.4 Initializing the Instrument (System Reset)" (p.110)
- (6) If the power goes out during integration, integration will stop. Integration will not resume when power to the instrument is restored.
- (7) If the timeout is set to 10 sec. and a signal of 1 Hz or less is input, a single measurement may take about 10 sec.
- (8) Before starting integration synchronized measurement, reset integrated values on both the master and slave. To perform a reset that is synchronized to the master, it is necessary for integration operation on the slave to be in the stopped or reset state.
- (9) Starting integration without first performing a reset results in additional integration.
- (10) Synchronization- and external control-based integration cannot be mixed on the slave. Always terminate external control and reset integration when performing synchronization-based integration.
- (11) When the slave's integration time setting is shorter than the master's integration time setting, stop timing cannot be synchronized since the slave's integration will stop first.
- (12) When performing synchronized measurement, once integration start/stop is performed on the slave, it may not be possible to synchronize operation, even if the same operation is performed on the master.
- (13) When performing integrated measurement using synchronized control, a difference of up to 0.7 sec. per hour may occur between the master's integration elapsed time display value (TIME) and the slave's integration elapsed time display value.

CAUTION



Avoid using an uninterruptible power supply (UPS) or DC/AC inverter with rectangular wave or pseudo-sine-wave output to power the instrument. Doing so may damage the instrument.

- When performing integration for an extended period of time, it is recommended to back up the instrument with an uninterruptible power supply (UPS). The instrument's maximum rated power is 30 VA or less. Ensure that you use a UPS with adequate capacity.
- After power is restored, measured values may be offset for reasons related to the instrument's internal circuitry. In this case, perform zero-adjustment after eliminating all input to the instrument, for example by deactivating power to measurement lines.
- Continuing to input voltage or current signals after an outage has caused the instrument to lose power may damage the instrument.

3.3.1 Integrated Value Display Format

The following tables describe the format of integrated values after they have been reset. When the number of digits in an integrated value increases, the number of digits in the format will also increase. Similarly, when the number of digits in an integrated value decreases, the number of digits in the format will also decrease.

No fewer digits may be used than in the format in the integration reset state.

Current integration format

Current range	1, 2, 5, 10, 20, 50 [mA]	100, 200, 500 [mA]	1, 2, 5 [A]	10, 20 [A]
Reset value	0.00000 mAh	00.0000 mAh	000.000 mAh	0.00000 Ah

Power integration format (150 V range)

Current range	1, 2, 5 [mA]	10, 20, 50 [mA]	100, 200, 500 [mA]	1, 2, 5 [A]	10, 20 [A]
Voltage range					
150 V	00.0000 mWh	000.000 mWh	0.00000 Wh	00.0000 Wh	000.000 Wh

Approach to integration reset values

One-tenth of the value of the display format for the current range or active power range is used as the integrated value format at reset.

Example:

	Display format	Integrated value format	Reset value
3 W range	3.0000 W	300.000 mWh	000.000 mWh
9 kW range	9.0000 kW	900.000 Wh	000.000 Wh

Even when a VT ratio and CT ratio are set, 1/10 of the corresponding display format is used as the integrated value format.

Example:

	Display format	Integrated value format	Reset value
600 W range 15 V × 10 (VT) × 200 mA × 20 (CT)	600.00 W	60.0000 Wh	00.0000 Wh

3.4 Viewing Harmonic Measured Values

The instrument displays the results of harmonic analysis for voltage, current, and active power.

Since all calculation processing is performed in parallel internally, you can obtain harmonic measured values with simultaneity with other measured values simply by switching display parameters.

Additionally, when the synchronization frequency is 45 Hz to 66 Hz, the instrument can perform harmonic measurement that compliant with IEC 61000-4-7:2002.

3.4.1 Setting the Synchronization Source

Set the synchronization source for the harmonic measurement to be performed with the instrument as described in "3.2.4 Setting the Synchronization Source (SYNC)" (p.48).

3.4.2 Method for Displaying Harmonic Measurement Parameters

The following table summarizes the instrument's harmonic measurement parameters and corresponding display methods:

Display mode	Normal display	Harmonic level display	Harmonic content percentage display
LEVEL lamp	off	on	off
HD% lamp	off	off	on
Measurement items	<ul style="list-style-type: none"> Total harmonic voltage distortion Total harmonic current distortion Fundamental wave voltage RMS value Harmonic current RMS value Fundamental wave active power Fundamental wave apparent power Fundamental wave reactive power Fundamental wave power factor Fundamental wave voltage current phase difference 	<ul style="list-style-type: none"> Harmonic voltage RMS value Harmonic current RMS value Harmonic active power 0th to 50th order 	<ul style="list-style-type: none"> Harmonic voltage content percentage Harmonic current content percentage Harmonic active power content percentage 0th to 50th order

Switching display modes

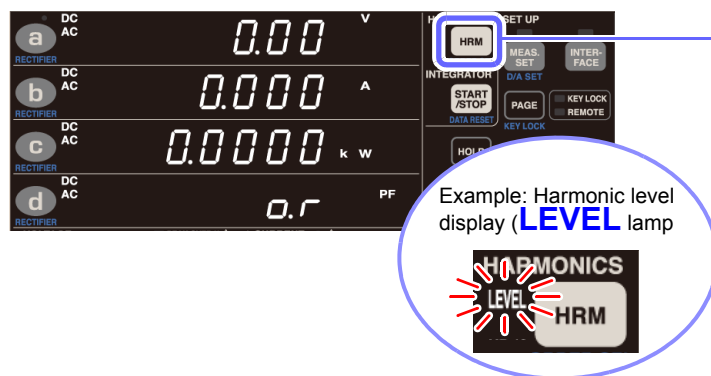

Press **HRM** repeatedly until the display mode you wish to use is shown.

You can check the display mode based on the **LEVEL** lamp and **HD%** lamp state.

3.4 Viewing Harmonic Measured Values

The following two harmonic display methods are available:

Displaying components for the same order as the display parameter (default state)

Example: If [odr 1] or similar is shown in area **a** on the display while displaying harmonics



- 1 Press **HRM** to light up **LEVEL** lamp.
- 2 Press **UP** or **DOWN** to change the order for display area **a**.

The component for the order specified for display area **a** will be shown for areas **b**, **c**, and **d** on the display.

Settings: **0** to **50**

Allocating components for different orders to areas **a**, **b**, **c**, and **d** on the display (ORDER SEL)



- 1 Press **SHIFT** to place the instrument in the shift state.
- 2 Press **HRM**.
- 3 Press **UP** or **DOWN** to change the order.

If all display areas indicate [- -], the “display the same order component” setting will be used.

Settings: **0** to **50** → **--** → **0** to **50**

To move areas **a**, **b**, **c**, or **d** on the display:

Press **BACK** or **NEXT** to select the display area you wish to set so that it flashes and then set as desired.

- 4 Press **HRM** or **SHIFT** to exit the Order Setting screen.

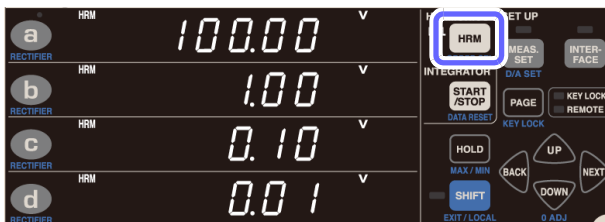

By allocating different orders to areas **a** through **d** on the display and then setting all the areas to the same measurement parameter, you can observe changes in each order.

Parameters shown with normal display parameters

Total harmonic voltage distortion (**THD V %**), total harmonic current distortion (**THD A %**)

Example: THD V%

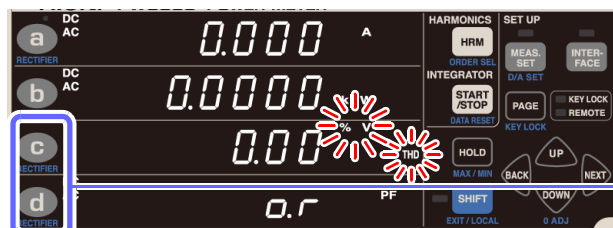

Press **c** or **d** to display **THD V %** or **THD A %** in the display area.

Parameters shown as fundamental wave parameters (displayed as RECTIFIER FND)

Fundamental wave voltage RMS value (**FND V**), fundamental wave current RMS value (**FND A**),

fundamental wave active power (**FND W**), fundamental wave apparent power (**FND VA**),

fundamental wave reactive power (**FND var**), fundamental wave power factor (**FND PF**),

fundamental voltage/current phase difference (**FND °**)

Example: FND V

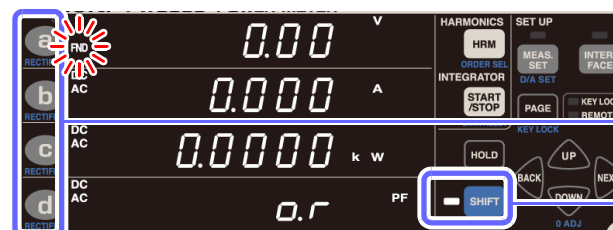

1 Press **SHIFT** to place the instrument in the shift state.

2 Press **a** through **d** to display **FND**.

(Press **a** through **d** to change the display parameter.)

Measurement parameters displayed using harmonic analysis (harmonic level, content percentage, rectifier FND [fundamental wave component]) are not averaged by the averaging function.

3.4 Viewing Harmonic Measured Values

Parameters shown as harmonic level (LEVEL)

Harmonic voltage RMS value (HRM V), harmonic current RMS value (HRM A), harmonic active power (HRM W)

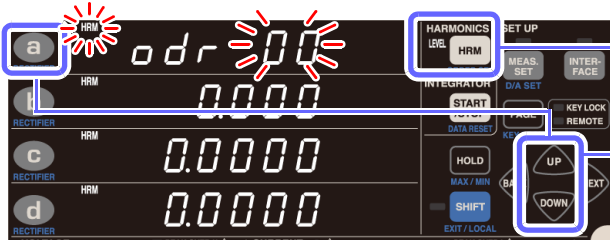

1 Press **HRM** to light up **LEVEL** lamp.

2 Press **a**, **UP**, or **DOWN** to change the harmonic order.

After pressing **a** or **UP**:

01 (1st order: fundamental wave component) → **02** (2nd order) → ... → **49** (49th order) → **50** (50th order) → **00** (0th order: DC component) → **01**

After pressing **DOWN**:

01 → **00** → **50** → **49** → ... → **02** → **01**

The harmonic level will be displayed in areas **b** through **d** on the display.

(Default display)

Display area **b**: Harmonic voltage RMS value

Display area **c**: Harmonic current RMS value

Display area **d**: Harmonic active power

(Press **b** through **d** to change the display parameter.)

■ Parameters displayed as harmonic content percentage (HD %)

Harmonic voltage content percentage (**HRM V %**), harmonic current content percentage (**HRM A %**), harmonic active power content percentage (**HRM W %**)

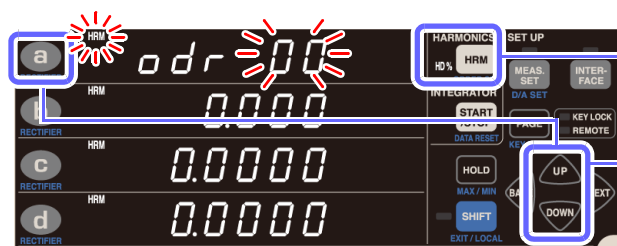

1 Press **HRM** to light up **HD %** lamp.

2 Press **a**, **UP**, or **DOWN** to change the harmonic order.

After pressing **a** or **UP** :

01 (1st order: fundamental wave component) → **02** (2nd order) → ... → **49** (49th order) → **50** (50th order) → **00** (0th order: DC component) → **01**

After pressing **DOWN** :

01 → **00** → **50** → **49** → ... → **02** → **01**

The harmonic content percentage will be displayed in areas **b** through **d** on the display.

(Default display)

Display area **b**: Harmonic voltage content percentage

Display area **c**: Harmonic current content percentage

Display area **d**: Harmonic active power content percentage

Press **b** through **d** to change the display parameter.

■ Parameters that can be downloaded with communications functionality

Harmonic voltage phase angle, harmonic current phase angle, harmonic voltage/current phase difference
These parameters cannot be displayed using keys on the instrument. They can only be downloaded using communications functionality. (See the Communications Command Instruction Manual.)

3.4.3 Setting the Harmonic Analysis Order Upper Limit

The instrument allows you to set an upper limit value for the harmonic analysis order. One example of how this setting can be used is to set a limit on the uppermost order during total harmonic distortion (THD) measurement.

1 Press **MEAS. SET**.

2 Press **PAGE** to switch to the analysis order upper limit settings screen. ([ordEr] will be displayed in display area a.)

3 Press **BACK** or **NEXT** until the display area **b** flashes.

4 Press **UP** or **DOWN** to set the upper limit value for analysis.

Default setting: 50
Setting range: 50 → 2 → 3 ... → 49 → 50 ...

When the setting is changed to a value other than the default setting of 50, the **HRM LIMIT** lamp will light up.

5 Press **MEAS. SET** to exit the settings.

The instrument will return to the normal display (Measurement screen).

The harmonic level and content percentage displays will include data up to the 50th order, even if the upper limit is set to a value other than 50.

If the upper limit does not flash

Failure of the value to flash indicates that the upper limit value cannot be changed. Take the following action to address the issue:

Status	Solution and reference for more information
During integration operation (RUN lamp lit up or flashing)	The upper limit value cannot be changed until the integrated value is reset (so that the RUN lamp turns off). See: "Canceling integration (resetting integrated values) (DATA RESET)" (p.65)
During display hold operation or maximum value/minimum value hold operation (HOLD , MIN , or MAX lamp lit up)	The upper limit value cannot be changed until this operation is canceled (so that the HOLD , MIN , or MAX lamp turns off). See: "Canceling the display hold state" (p.106) "Switching the display among the maximum, minimum, and instantaneous values" (p.107)

3.4.4 About the HRM ERROR lamp

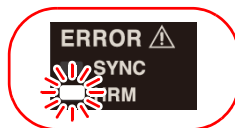
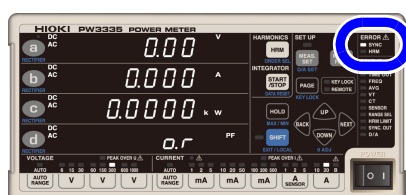

Accurate harmonic measurement cannot be performed while the **HRM** lamp (ERROR) is lit up.

- The **HRM** lamp (ERROR) will light up when the instrument receives input outside the synchronization frequency range for harmonic measurement or if it is unable to perform harmonic measurement due to the effects of noise. At that time, the instrument will show the invalid data display [- - - -].
- Since measurement processing will be reset when integration starts, preventing harmonic analysis from being performed properly during that interval, the **HRM** lamp (ERROR) will light up momentarily.

3.5 Performing Synchronized Measurement with Multiple Instruments (Multiple-instrument Synchronized Measurement)

You can perform synchronized measurement by connecting multiple (up to eight: one master and up to seven slaves) instruments (PW3335) with optional 9165 Connection Cord (BNC cable).

This functionality can be used to perform simultaneous measurement of multiple circuits by operating only the instrument (PW3335) set up as the master (instrument setting of OUT) and thereby controlling the instrument (PW3335) set up as the slave (instrument setting of IN).

The instrument (PW3335) set up as the slave will match the timing of the instrument (PW3335) set up as the master for the following operations:

- Internal calculations
- Display updates
- Data updates
- Integration start, stop, and reset
- Display hold
- Zero-adjustment
- Key lock

The PW3335 can also be used with the PW3336 and PW3337 series of power meters to perform synchronized measurement.

CAUTION



- To avoid damaging the instruments, do not connect or disconnect cables while the instruments are turned on.
- In synchronized measurement, do not input any signal other than those specifically supported by the instrument's synchronized measurement function. Doing so may result in malfunction or damage.



- Use a common ground for instruments (PW3335) that are performing simultaneous measurement. If different grounding is used, a potential difference will occur between the master ground and the slave ground. Connecting the connection cable (for synchronization) while there is such a difference may result in malfunction or damage.

Connecting 2 instruments (PW3335) with a synchronization cable

You will need: Two instruments, one 9165 Connection Cord

- 1** Verify that both instruments (PW3335) have been turned off.
- 2** Connect the instruments' external synchronization terminals (EXT. SYNC) with the 9165 Connection Cord.

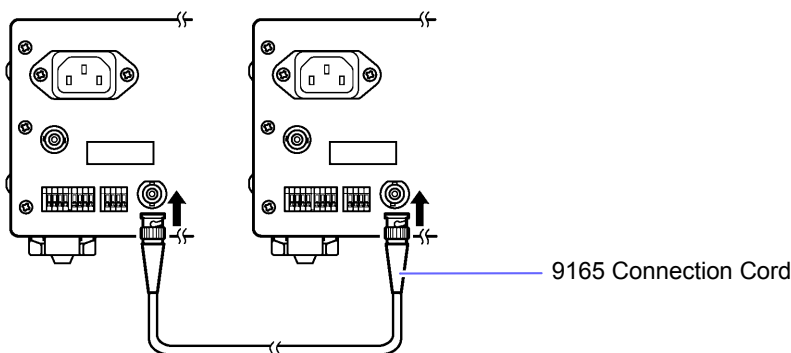

- 3** Turn on the two instruments (PW3335). (The order in which the instruments are turned on does not matter.)

- When performing synchronized measurement with more than three instruments, connect the instrument in parallel using a BNC adaptor such as a BNC T-adaptor (jack-plug-jack).

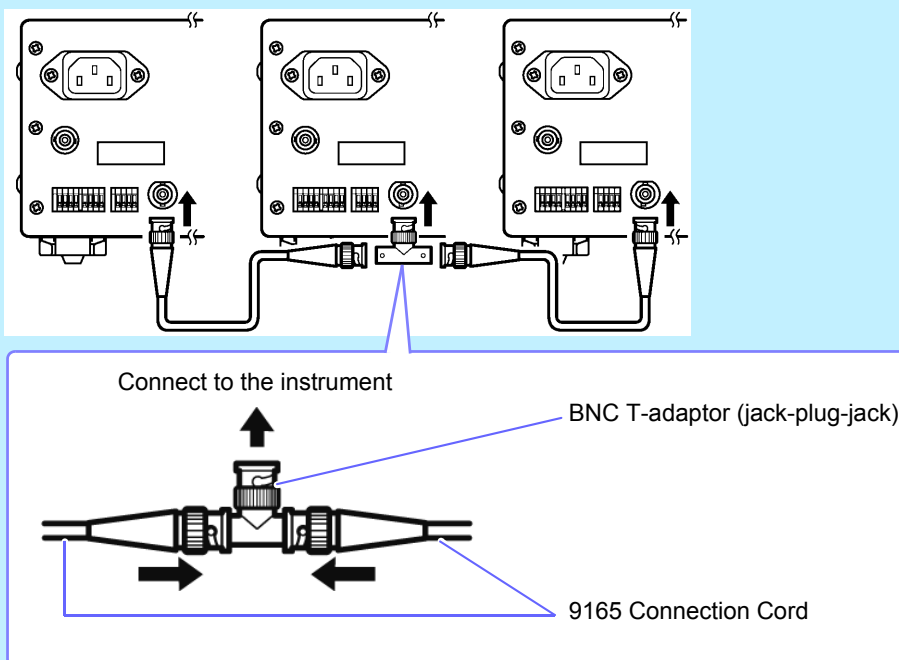

- During synchronized measurement, control signals are sent using the 9165 Connection Cord. Never disconnect the connection cable during synchronized measurement. Doing so will prevent these signals from being properly supplied.

Configuring synchronized measurement

You can set the master and slave by configuring the synchronized control input and output settings.

Setting	Description	SYNC.OUT lamp
OFF (Default setting)	Turns off the synchronized control function. The external synchronization terminal (EXT.SYNC) setting is [IN], but input signals are ignored. External synchronized operation is not performed.	off
IN	Sets the instrument as the slave. The external synchronization terminal (EXT.SYNC) is set to [IN], and dedicated synchronization signals can be input. Synchronization signals will be received from the external synchronization terminal (EXT.SYNC), and processing will be performed accordingly. When synchronization signals are received from an external source, the SYNC.OUT lamp will flash.	off, flash
OUT	Sets the instrument as the master. The external synchronization terminal (EXT.SYNC) will be set to [OUT], and dedicated synchronization signals will be output. Synchronization signals will be output from the external synchronization terminal (EXT.SYNC).	on

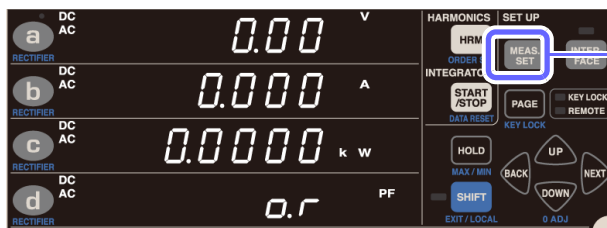

1 Press **MEAS. SET**.

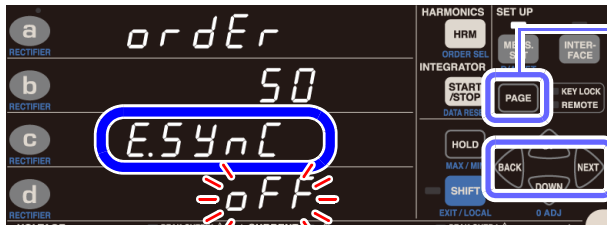

2 Press **PAGE** to switch to the synchronized measurement settings screen. ([E.SynC] will be displayed in display area c.)

3 Press **BACK** or **NEXT** until the display area d flashes.

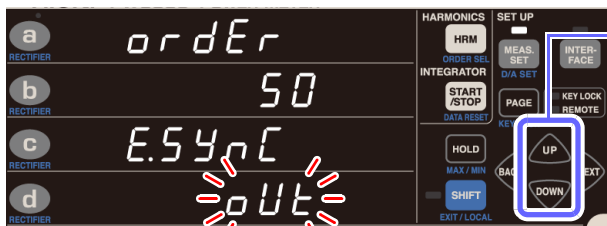

4 Press **UP** or **DOWN** to configure the synchronized control I/O setting.

Default setting: OFF
Setting: **OFF** → **in** → **oUt** ...

The **SYNC.OUT** lamp will light up when set to **oUt**.



5 Press **MEAS. SET** to exit the settings.

The instrument will return to the normal display (Measurement screen).





When drawing external synchronization from two or more instruments, be sure to set only one as the **oUt** power meter. Use of two or more **oUt** instruments may cause damage or malfunction.

- When an instrument is set to **oUt**, the synchronization signal is output from the external synchronization terminal (EXT.SYNC) according to the internal processing timing (200 ms).
- When an instrument is set to **in**, it will wait for the synchronization signal from the power meter set to **oUt**. If no synchronization signal is received before 210 ms or more elapses, the instrument will display [**Err.20**].

See: "6.2 Error Indication" (p.170)

Synchronized operations

Internal calculations	The slave matches the master's timing (when the number of averaging iterations is 1 [the default setting]).
Display updates	
Data updates	
Integration start/stop and reset	Integration starts, stops, and is reset at the same timing as the master on the slave by means of  operation on the master.
Display hold	When  is pressed on the master, the master and slave both enter the hold state. To cancel the display hold state, press  again.
Zero Adjustment	Zero-adjustment is performed on the slave in synchronization with zero-adjustment on the master.
Key-lock	When the key lock is activated on the master, it is also activated on the slave. When the key lock is canceled on the master, it is also canceled on the slave.

- Before starting integration synchronized measurement, reset integrated values on both the master and slave. To perform a reset that is synchronized to the master, it is necessary for integration operation on the slave to be in the stopped or reset state.
- Starting integration without first performing a reset results in additional integration.
- If the number of averaging iterations settings on the master and slave differ from the default setting, display updates will not be synchronized.
- Synchronization and external control-based integration cannot be mixed on the slave. Always terminate external control and reset integration when performing synchronization-based integration.
- When the slave's integration time setting is shorter than the master's integration time setting, stop timing cannot be synchronized since the slave's integration will stop first.
- When performing synchronized measurement, once integration start/stop, display hold, zero-adjustment, or key lock operation is performed on the slave, it may not be possible to synchronize operation, even if the same operation is performed on the master.
- When performing integrated measurement using synchronized control, a difference of up to 0.7 sec. per hour may occur between the master's integration elapsed time display value (TIME) and the slave's integration elapsed time display value.
- Canceling the hold state on the master will cause all hold states (display, maximum value, and minimum value) to be canceled on the slave.

3.6 External Control

By connecting an external device to the instrument's external control terminals and sending signals to the instrument from that device, the instrument can be controlled, for example to start and stop integration and reset integrated values.

External control terminal (EXT.CONTROL)

The external control terminals are input terminals for controlling the instrument by means of either 0/5 V logic signals or short/open contact signals.

External control terminals and description of control

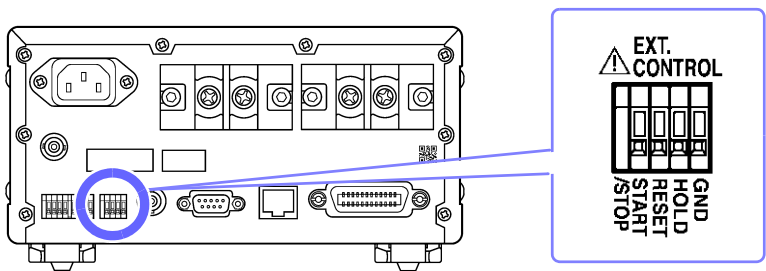

Terminal name	Description
START/STOP	Starts/stops integration. When a high (5 V or open) or low (0 V or shorted) signal is input to this terminal, integration starts. When the signal changes from low to high, integration stops.
RESET	Resets integrated values. When this terminal is set to low for at least 200 ms, integrated values are reset during that period.
HOLD	Display hold. Holds the display when this terminal changes from high to low. The display hold is canceled when the terminal changes from low to high.
GND	Connect to the external device's GND terminal.

External control signals are detected using the intervals illustrated in the following timing diagrams, but there may be a delay in the display depending on the input signal frequency, synchronization signal, timeout, and other settings.

Integration start/stop (START/STOP terminal)

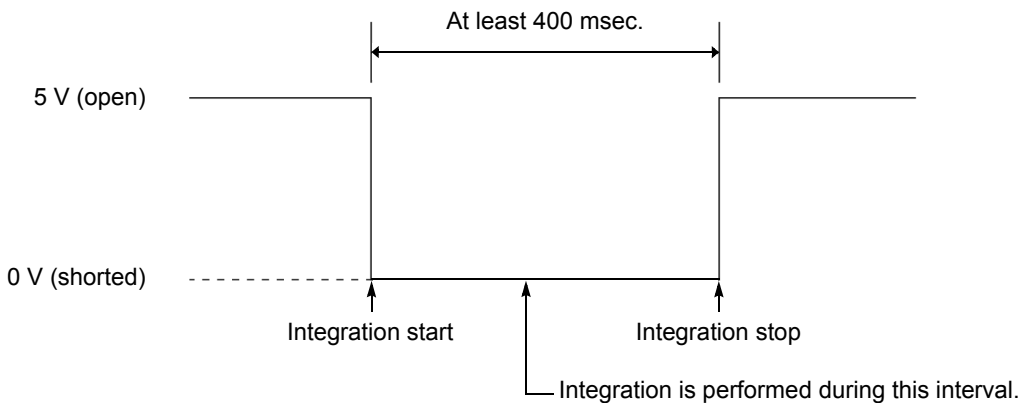

- When integration is started with external control, it can only be stopped by external control. The integration set time is ignored. If you attempt to stop integration with **START/STOP**, [Err.11] will be displayed.
- A delay (data update interval) of up to 200 msec. will occur between input of the integration start signal and the actual start of integration.
- The **EXT** lamp will light up while integration triggered by external control is being performed.



Integrated value reset (RESET terminal)

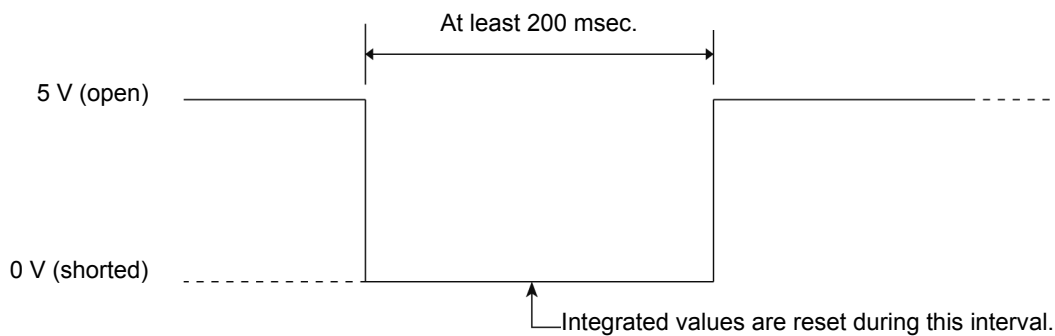

- While integration is being performed (while the **RUN** lamp is lit up), integrated values cannot be reset. Attempting to do so will cause [Err.15] to be displayed.
- A delay (data update interval) of up to 200 msec. will occur between input of the integration reset signal and the actual integration reset.

Display hold (HOLD terminal)

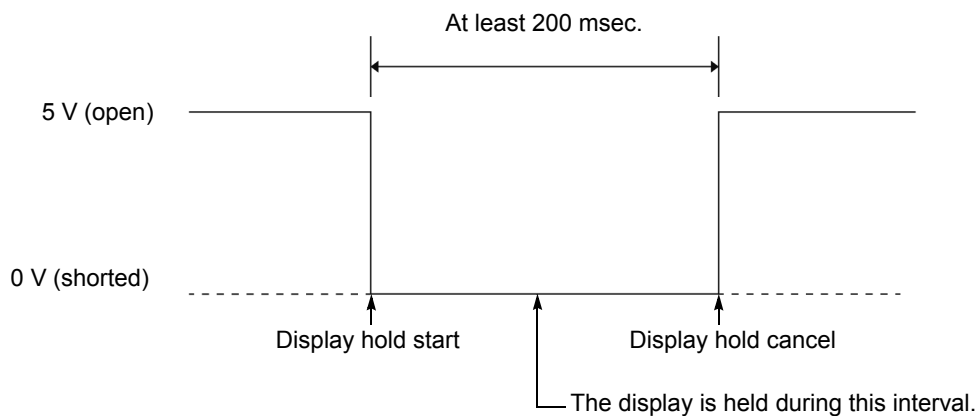

A delay (data update interval) of up to 200 msec. will occur between input of the hold signal and the actual hold.

External control terminal internal circuit schematic

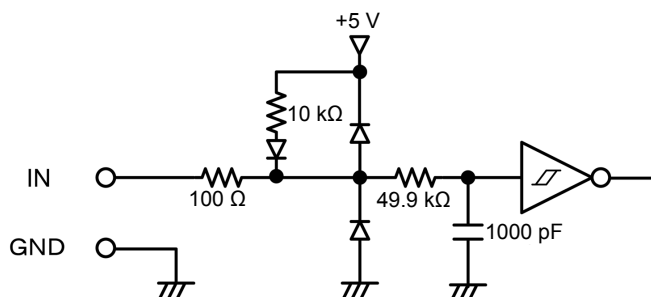

Connecting wires to the external control terminals

Before connecting wires to the terminals, see "Connecting, Input and Measurement" (p.8).

CAUTION



The external control terminals are input terminals for controlling the instrument by means of either short/open contact signals or 0/5 V logic signals. Do not input a voltage in excess of 5 V.



To avoid an electrical accident, use the specified wire type.

Connect the wires to the terminals for the parameter you wish to control. Connect the GND terminal on the instrument's external control terminals to the Lo (0 V) side of the contact signal or logic signal.

See: "External control terminals and description of control" (p.82)

Required item:

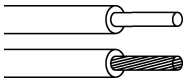

Wires

Recommended wires

Single strand diameter: ϕ 0.65 mm (AWG22)

Multi-strand: 0.32 mm² (AWG22)

Strand diameter: At least ϕ 0.12 mm or greater

Usable wires

Single strand diameter: ϕ 0.32 mm to ϕ 0.65 mm (AWG28 to AWG22)

Multi-strand: 0.08 mm² to 0.32 mm² (AWG28 to AWG22)

Strand diameter: At least ϕ 0.12 mm or greater

Standard insulation stripping length 8 mm



Flathead screwdriver

Shaft diameter: ϕ 3 mm

tip width: 2.6 mm

1 Press down on the button above each of the instrument's external control terminals using a tool, such as a flat head screwdriver.

2 While the button is depressed, insert the wire into the electric wire connection hole.

3 Release the button.
The electric wire is locked in place.

To remove the wire:

Hold the button while pulling the wire out.

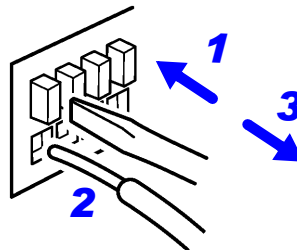

3.7 Using D/A Output

PW3335-02

PW3335-04

The PW3335-02 and PW3335-04 generate voltage output in response to input from the D/A output terminals.

Level (analog) output

Converts the instrument's measured values into signal levels and outputs a DC voltage. The output voltage is updated in response to display updates (data updates: approximately every 200 ms). It is possible to record fluctuations over extended periods of time by combining this functionality with a data logger or recorder.

High-speed level output

Generates level (analog) output for each cycle of the input voltage and input current. Additionally, it is possible to generate level output for the active power calculated for each cycle of the voltage or current that has been set as the synchronization source. It is possible to observe power consumption and other properties for abruptly fluctuating loads one wave at a time by combining this functionality with a recorder or other instrument.

Waveform output

Samples the voltage and current input to the instrument at approximately 700 kHz, performs D/A conversion, and outputs an instantaneous voltage waveform, instantaneous current waveform, and instantaneous power waveform. It is possible to observe equipment rush current and instantaneous power waveforms by combining this functionality with an oscilloscope or other instrument.

When the frequency of input to the set synchronization source is less than 5 Hz, the output update rate for level output and high-speed level output varies with the frequency of the input to the synchronization source. Example: If the frequency of input to the synchronization source is 0.8 Hz, the output update rate will be $1/0.8 = 1.25$ sec.

Output terminals and description of output

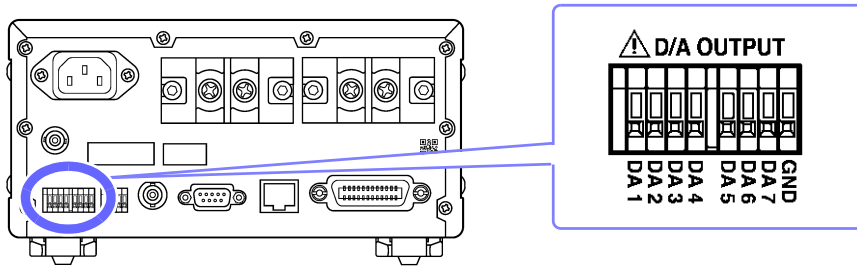

Available output parameters and output voltages (DA1 to DA7)

	Output voltage	Output parameters
Level output	Select from 2 V (STD.2) and 5 V (STD.5).	Voltage (V), Current (A), Active power (W), Apparent power (VA), Reactive power (var), Power factor (PF), Phase angle (°), Voltage frequency (V Hz), Current frequency (A Hz), Time average current (T.AV A), Time average active power (T.AV W), Current integration (Ah, Ah+, Ah-), Active power integration (Wh, Wh+, Wh-), Voltage crest factor (CF V), Current crest factor (CF A), Voltage ripple rate (RF V %), Current ripple rate (RF A %), Total harmonic voltage distortion (THD V %), Total harmonic current distortion (THD A %), Maximum current ratio (MCR)
High-speed level output	Select from 2 V (FASt.2) and 5 V (FASt.5)	Voltage (V), Current (A), Active power (W)
Waveform output	1 V (FASt) Instantaneous voltage and instantaneous current RMS level Instantaneous power Average level	Instantaneous voltage (V), Instantaneous Current (A), Instantaneous power (W)

Output circuits

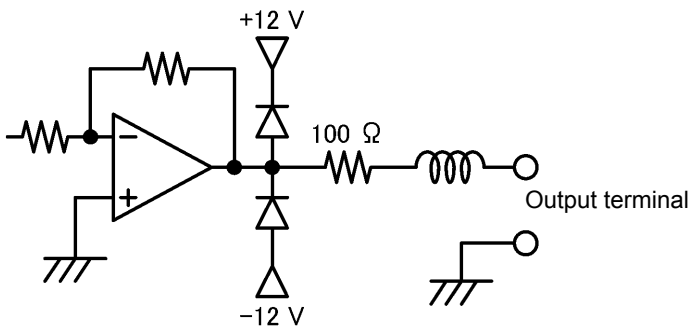

The output impedance of each output terminal is approximately 100 Ω. When connecting a recorder, DMM, or other instrument, use a device with high input impedance (1 MΩ or greater).

A maximum voltage of approximately ±12 V may be output from D/A output terminals.

Connecting wires to D/A output terminals

Before connecting wires to the terminals, see "Connecting, Input and Measurement" (p.8).

CAUTION



To avoid damaging the instrument, do not input voltage to the output terminals or short the terminals.



To avoid an electrical accident, use the specified wire type.

Connect wires to the terminals that you have set to output the desired parameters. Connect the instrument's GND terminal to the GND terminal of the data logger, recorder, or other output device.

See: "Output terminals and description of output" (p.86)

Required item:

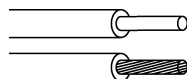

Wires

Recommended wires

Single strand diameter: ϕ 0.65 mm (AWG22)

Multi-strand: ϕ 0.32 mm² (AWG22)

Strand diameter: At least ϕ 0.12 mm or greater

Usable wires Single strand diameter: ϕ 0.32 mm to ϕ 0.65 mm (AWG28 to AWG22)

Multi-strand: 0.08 mm² to 0.32 mm² (AWG28 to AWG22)

Strand diameter: At least ϕ 0.12 mm or greater

Standard insulation stripping length 8 mm



Flathead screwdriver

Shaft diameter: ϕ 3 mm

tip width: 2.6 mm

- 1** Press down on the button above each of the instrument's D/A output terminals using a tool, such as a flat head screwdriver.
- 2** While the button is depressed, insert the wire into the electric wire connection hole.
- 3** Release the button.
The electric wire is locked in place.

To remove the wire:

Hold the button while pulling the wire out.

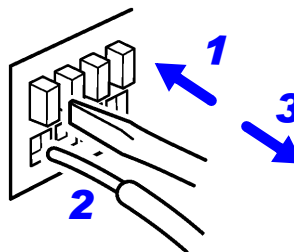

3.7.1 Level Output, High-speed Level Output, and Waveform Output

The PW3335 provides seven D/A output terminals. You can set each to a desired output parameter to generate voltage output based on the output parameter input.

For example, if you set the output parameter to active power (W), the terminal will output a voltage based on the active power.

Although there are differences for certain output parameters, the basic approach implemented by this functionality is described below.

See: "Appendix 2 Detailed Specifications of Output" (p. A2)

Level output

- 2 V DC at $\pm 100\%$ of the STD.2 set range
- 5 V DC at $\pm 100\%$ of the STD.5 set range

High-speed level output

- 2 V DC at $\pm 100\%$ of the FAS.t.2 set range
- 5 V DC at $\pm 100\%$ of the FAS.t.5 set range

Waveform output

- 1 V f.s. at 100% of the FAS.t set range

Terminal	Default setting	Description
DA1	V : AC+DC, STD.2	Each D/A output terminal can be set to any of the following: <ul style="list-style-type: none"> • Level output • High-speed level output • Waveform output See: "Appendix 2 Detailed Specifications of Output" (p. A2)
DA2	A : AC+DC, STD.2	
DA3	W : AC+DC, STD.2	
DA4	PF : AC+DC, STD.2	
DA5	V : AC+DC, FAS.t	
DA6	A : AC+DC, FAS.t	
DA7	W : AC+DC, FAS.t	

- For more information about D/A output, see "D/A Output Specifications" (p.152)
- Available output methods vary with the output parameter and rectifier.
 - See:** "Appendix 2 Detailed Specifications of Output" (p. A2)
- If settings have resulted in a [Lo.] display, output will be 0 V. However, when auto-range integration is enabled, that output is maintained.
- Level is generated for instantaneous values even when display hold or averaging processing is being performed.
- Level output cannot be generated for voltage peak values, current peak values, or harmonic orders.
- Never input a signal to an output terminal. Doing so may damage the instrument.

For the PW3335-02 and PW3335-04, the DA1 to DA7 output parameters are the same as the output parameters for LR8410 Link compatible loggers. For the PW3335 and PW3335-03, the default parameters for the DA1 to DA4 terminals are output parameters for LR8410 Link compatible loggers (DA5 to DA7 cannot be used).

See: "3.11 Connecting the Instrument to Hioki LR8410 Link compatible Logger" (p.115)

Setting the output parameter, rectifier, and output method for D/A output channels



- 1** Press **SHIFT** to place the instrument in the shift state.



- 2** Press **MEAS. SET D/A SET** to switch to the D/A output parameter settings screen. ([dA] will be displayed in display area a.)

- 3** Press **BACK** or **NEXT** until the display area **a** flashes.



- 4** Press **UP** or **DOWN** to select the D/A channel you wish to set.

- 5** Press **BACK** or **NEXT** until the output parameter flashes.



- 6** Press **UP** or **DOWN** to select the parameter you wish to output.

The flashing unit symbol will indicate the parameter selected for D/A output.

V → A → W → VA → var → PF → ° → VHz
 → AHz → T.AV-A → T.AV-W → Ah+ → Ah-
 → Ah → Wh+ → Wh- → Wh → CF-V →
 CF-A → RF-V % → RF-A % → THD-V % →
 THD-A % → MCR ...

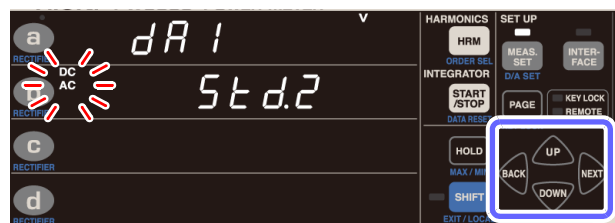

- 7** Press **BACK** or **NEXT** until the rectifier flashes.

- 8** Press **UP** or **DOWN** to change the rectifier.

Default setting: AC+DC

Settings: **AC+DC** → **AC+DC Umn** → **DC** → **AC**
 → **FND** ...

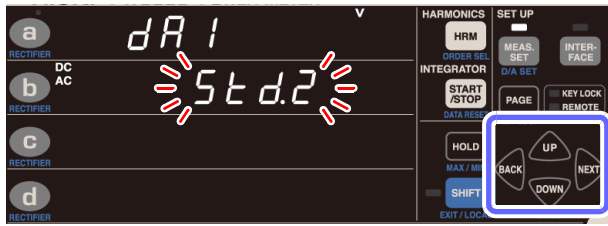

9 Press **BACK** or **NEXT** until the output method flashes.

10 Press **UP** or **DOWN** to change the output method.

The available output parameters vary with the output method and rectifier.

Example: For V and AC+DC
Std.2 → **Std.5** → **FASt.2** → **FASt.5** → **FASt** ...

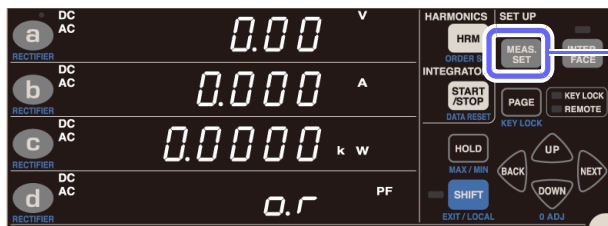

11 Press **MEAS. SET** to exit the settings.

The instrument will return to the normal display (Measurement screen).

For Lo. display

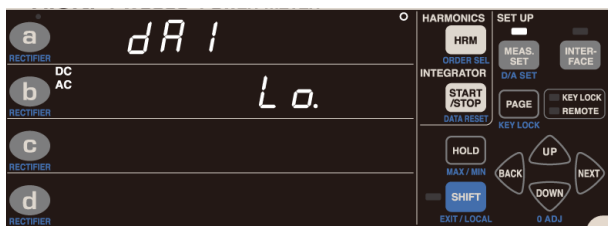

If the **Lo.** display is active, output will be 0 V.

The display will indicate "Lo." if an unmeasured parameter is specified. Ordinarily, the instrument will output 0 V while the "Lo." Display is active, but if auto-range integration is enabled, that output will be maintained.

For frequency (V Hz or A Hz)



Sets the frequency value for the output f.s. (5 V).

Default setting: 500 Hz
 Settings: **500** → **5 k** → **50 k** → **500 k** → **0.5** → **5** → **50** ... [Hz]

For integrated value (Ah+, Ah-, Ah, Wh+, Wh-, or Wh)



Sets the integrated value for the output f.s. (5 V).

Default setting: 5 k
 Settings: **5 k** → **50 k** → **500 k** → **5 M** → **50 M** → **500 M** → **5000 M** → **5 m** → **50 m** → **500 m** → **5** → **50** → **500** → **5 k** ...

Setting D/A output when enabling auto-range integration

During auto-range integration mode operation, you can set the current range (200 mA to 20 A, b, totAL [total]) you wish to output for the following measurement parameters.

●: Current range can be set Lo.:No measurement data

Measurement items		Rectifier					Rated output voltage
		AC+DC	AC+DC+Umn	DC	AC	FND	
Time average current	T.AV A	Lo.*	Lo.*	●	Lo.	Lo.	Relative to $\pm 100\%$ of the range STD.2: ± 2 V DC STD.5: ± 5 V DC
Time average active power	T.AV W	●	●	●	Lo.	Lo.	
Current integration	Ah+ Ah- Ah	Lo.	Lo.	●	Lo.	Lo.	5 V when set value is reached Example: If set to 5 kAh, 5 V DC at 5 kAh
Active power integration	Wh+ Wh- Wh	●	●	●	Lo.	Lo.	5 V when set value is reached Example: If set to 5 kWh, 5 V DC at 5 kWh

In the b and totAL ranges, 100% of current is equivalent to 20 A, and 100% of power is equivalent to 100% of the voltage range \times 20 A.



First, enable auto-range integration. (p.67)

1 Press **SHIFT** to place the instrument in the shift state.

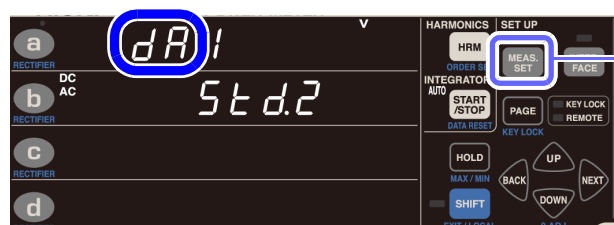

2 Press **MEAS. SET** to switch to the D/A output parameter settings screen. ([dA] will be displayed in display area a.)

For time average (T.AV A or T.AV W)

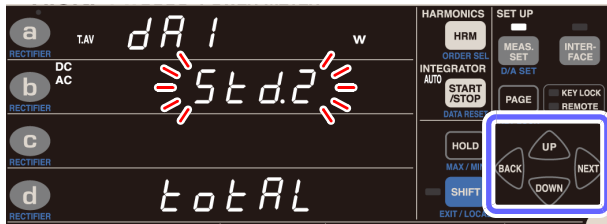

3 Press **BACK** or **NEXT** until the parameter flashes.

4 Press **UP** or **DOWN** to select the parameter you wish to output.

If you select time-average, the current range will be shown in display area **d**.

5 Press **BACK** or **NEXT** until the output method flashes.

6 Press **UP** or **DOWN** to select the output method.

The available output method vary with the output parameters and rectifier.

Example: For T.AV W and AC+DC
 Default setting: STD.2
 Settings: **Std.2** → **Std.5** → **Std.2** ...

7 Press **BACK** or **NEXT** until the current range flashes.

8 Press **UP** or **DOWN** to select the current range you wish to output.

Default setting: totAL
 Settings: **totAL** → **200 mA** → **500 mA** → **1 A** → **2 A** → **5 A** → **10 A** → **20 A** → **b** → **totAL** ...

9 Press **MEAS. SET** to exit the settings.

The instrument will return to the normal display (Measurement screen).

For integrated value (Ah+, Ah-, Ah, Wh+, Wh-, or Wh)

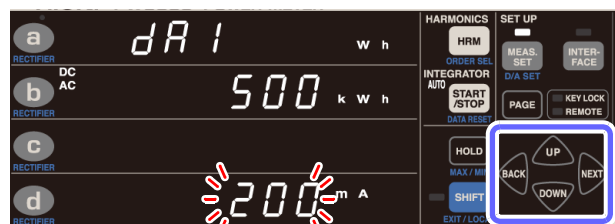

3 Press **BACK** or **NEXT** until the parameter flashes.

4 Press **UP** or **DOWN** to select the parameter you wish to output.

If you select integrated value, the current range will be shown in display area **d**.

5 Press **BACK** or **NEXT** until the output f.s. flashes.

6 Press **UP** or **DOWN** to select the output f.s..

Example: For Wh and AC+DC

Default setting: 5 k

Settings: 5 k → 50 k → 500 k → 5 M → 50 M →
500 M → 5000 M → 5 m → 50 m →
500 m → 5 → 50 → 500 → 5 k ...

7 Press **BACK** or **NEXT** until the current range flashes.

8 Press **UP** or **DOWN** to select the current range you wish to output.

Default setting: totAL

Settings: totAL → 200 mA → 500 mA → 1 A →
2 A → 5 A → 10 A → 20 A → b →
totAL ...

9 Press **MEAS. SET** to exit the settings.

The instrument will return to the normal display (Measurement screen).

Example uses

D/A output can be used in combination with a data logger or recorder. For more information about the output voltage, output resistance, response time, and output update rate, see "Chapter 5 Specifications" (p.139).

Example uses of level output

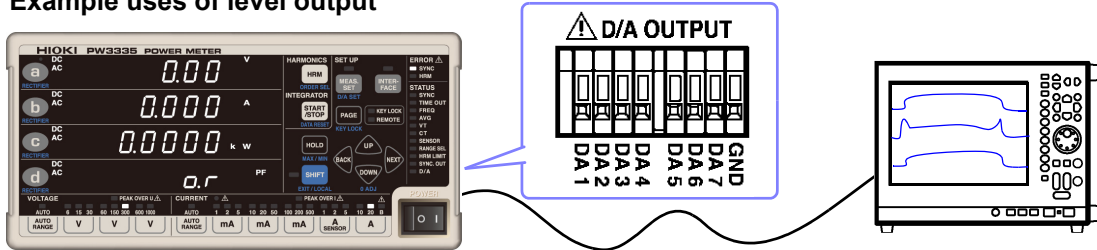

- When using a VT ratio or CT ratio, output voltages are determined by multiplying the range value by the VT ratio or CT ratio.
- When the measurement range is set to auto-range operation, the output rate for level output and high-speed level output will also change with changes in the range. When measuring lines characterized by abrupt changes in measured values, exercise care not to mistake the range conversion. It is recommended to use a fixed range in measurement applications such as this.
- Output of 0 V is generated while displaying invalid data.

Example uses of waveform output

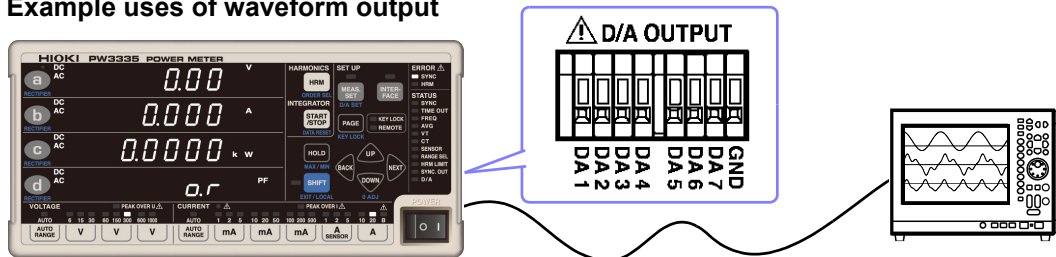

- When using a VT ratio or CT ratio, the value obtained by multiplying the range by the VT ratio or CT ratio serves as the 1 V RMS value.
- When the measurement range is set to auto-range operation, the output rate for waveform output will also change with changes in the range. When measuring lines characterized by abrupt changes in measured values, exercise care not to mistake the range conversion. It is recommended to use a fixed range in measurement applications such as this.
- Waveform output will change even in the display hold state and during averaging processing.

Output voltage of level output

Voltage, current

STD.2 and FAST.2 (2 Vf.s.) settings

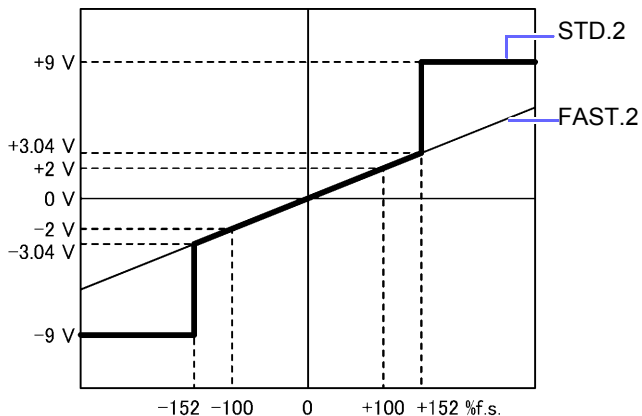

STD.5 and FAST.5 (5 Vf.s.) settings

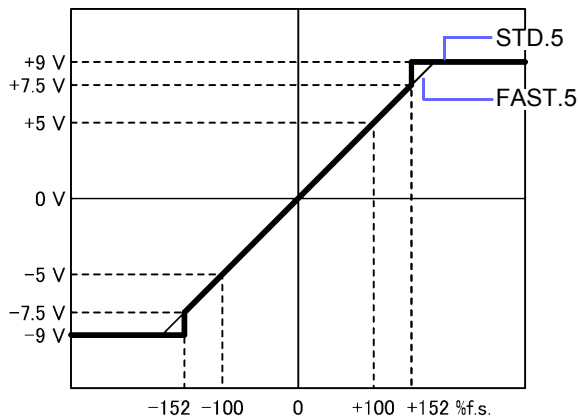

Active power: STD.2 and FAST.2 (2 Vf.s.) settings
Apparent power, reactive power:
 STD.2 (2 Vf.s.) settings

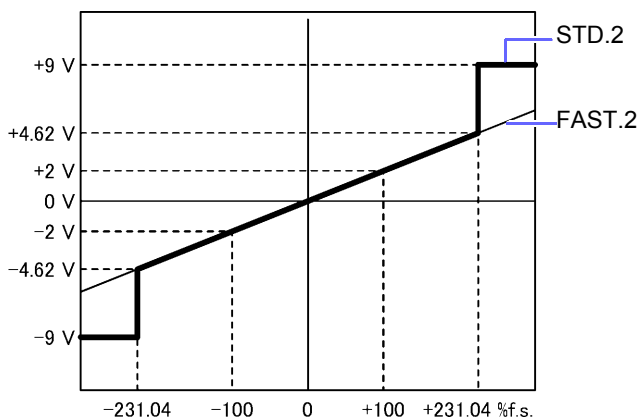

Active power: STD.5 and FAST.5 (5 Vf.s.) settings
Apparent power, reactive power:
 STD.5 (5 Vf.s.) settings

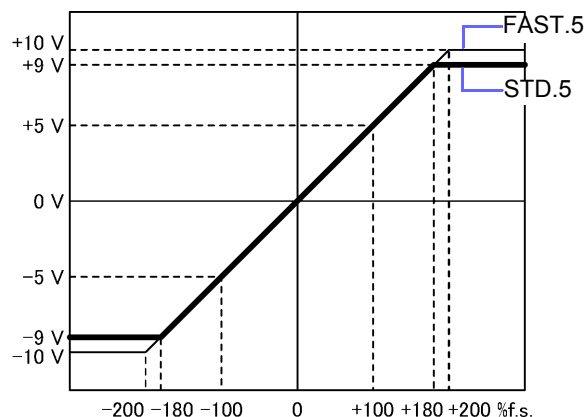

Power factor

STD.2 (2 Vf.s.) settings

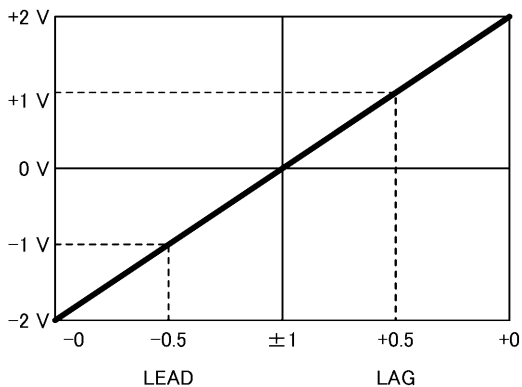

STD.5 (5 Vf.s.) settings

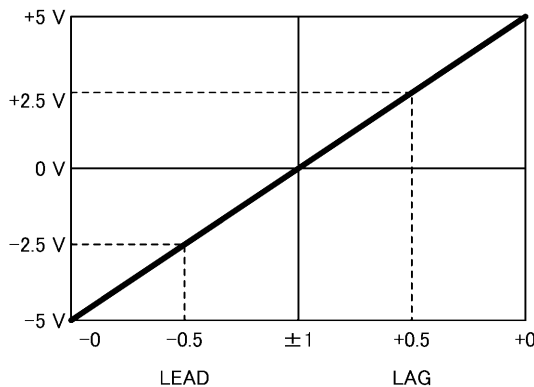

Phase angle

STD.2 (2 Vf.s.) settings

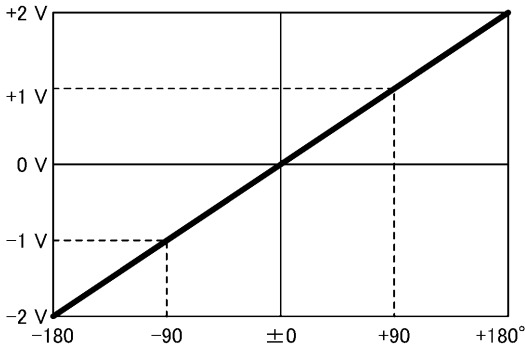

STD.5 (5 Vf.s.) settings

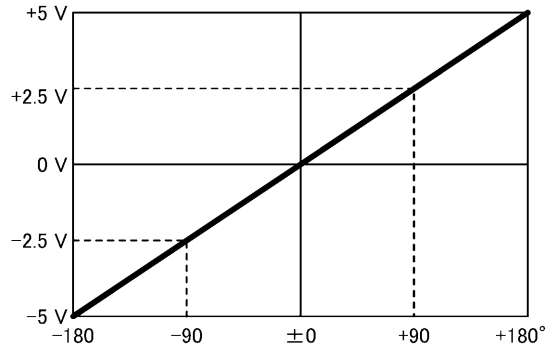

Voltage/ current ripple rate, total harmonic voltage/ current distortion

STD.2 (2 Vf.s.) settings

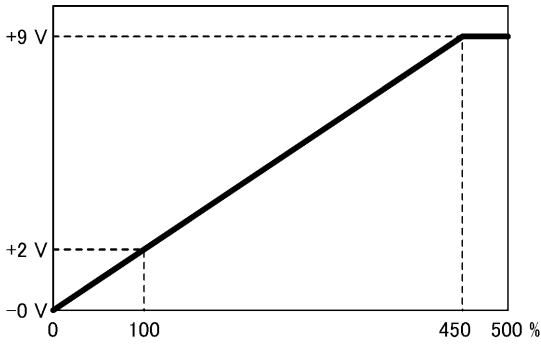

STD.5 (5 Vf.s.) settings

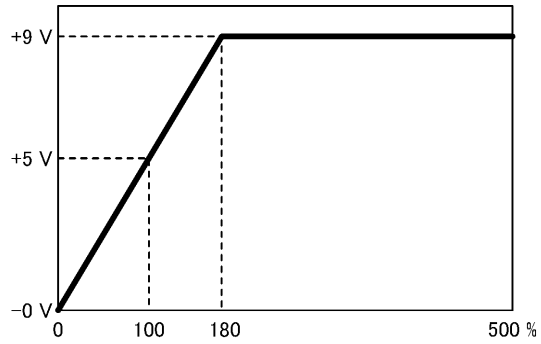

Although the voltage ripple rate, current ripple rate, total harmonic voltage distortion, and total harmonic current distortion are displayed up to 500.00%, level output changes to +9 V at 450% when using the STD.2 (2 V) setting and 180% when using the STD.5 (5 V) setting, voltages in excess of that value are not output.

Voltage/ current crest factor

STD.2 (2 Vf.s.) settings

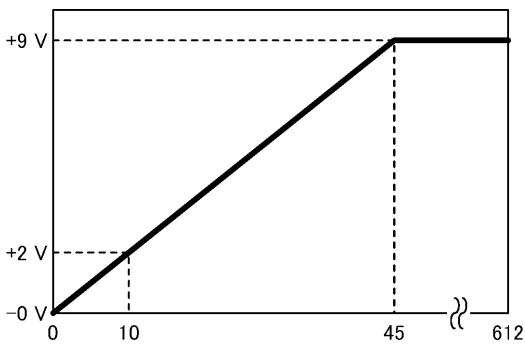

STD.5 (5 Vf.s.) settings

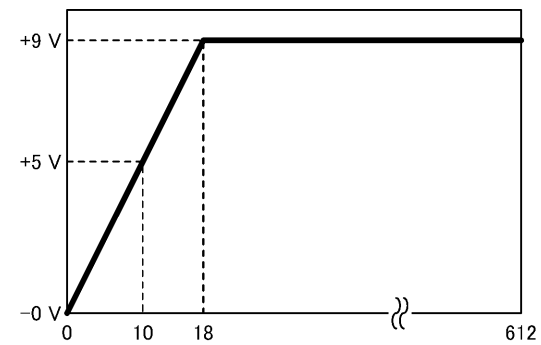

Although the voltage crest factor and current crest factor are displayed up to 612.00, level output changes to +9 V at 45 when using the STD.2 (2 V) setting and 18 when using the STD.5 (5 V) setting, voltages in excess of that value are not output.

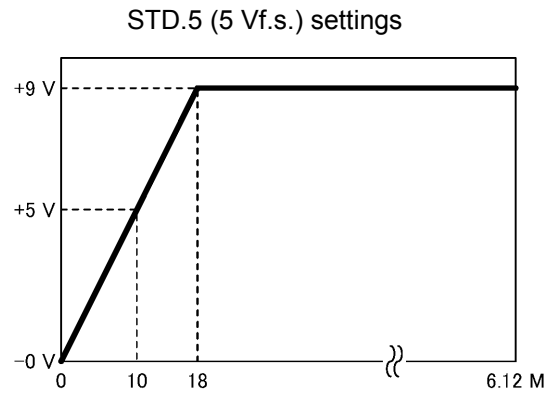
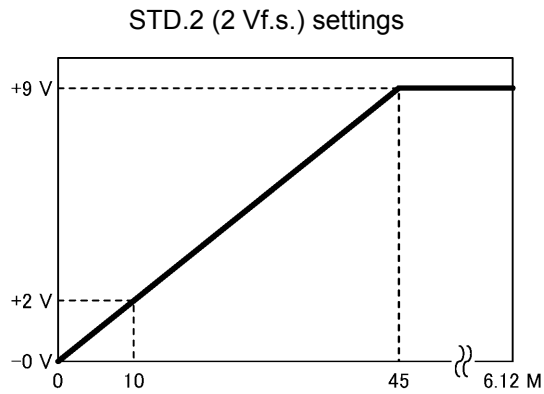
Maximum Current Ratio

Although the maximum current ratio is displayed up to 6.12 M, level output changes to +9 V at 45 when using the STD.2 (2 V) setting and 18 when using the STD.5 (5 V) setting, voltages in excess of that value are not output.

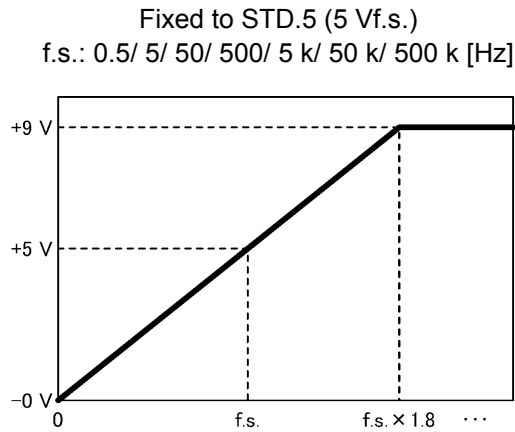
Frequency

Frequency level output (fixed to STD.5) changes to +5 V at the selected f.s. value and +9 V at the frequency that is 1.8 times the f.s. value, voltages in excess of that value are not output. (The default f.s. setting is 500 Hz.)

3.7 Using D/A Output

Current integration, active power integration

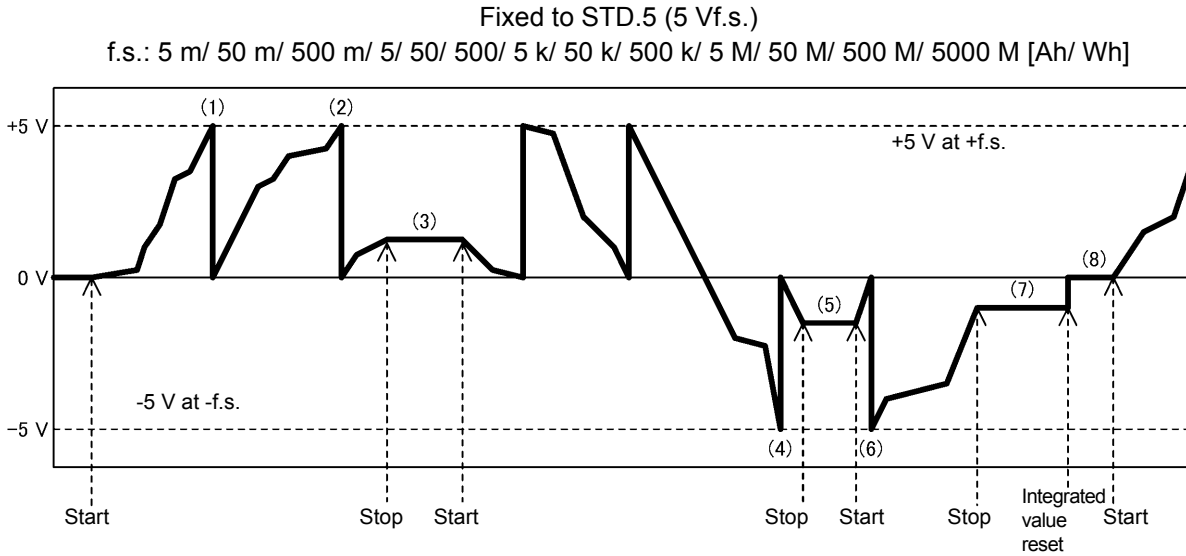

Level output (fixed to STD.5) functions as follows for current integration and active power integration. (The default f.s. setting is 5 k [Ah/ Wh])

(1), (2), (4), (6)	<p>Level output for current integration and active power integration changes to +5 V or -5 V at a whole-number multiple of the selected f.s. value. When the current integration or active power integration value exceeds the selected f.s. value, level output changes to 0 V, and then voltage output continues from 0 V depending on the integrated value.</p> <p>Example: If the f.s. value in the above figure is 5 kWh Level output changes to +5 V or -5 V at whole-number multiples of +5 kWh or -5 kWh (5, 10, 15, etc.). (1) +5 kWh (2) +10 kWh (4), (6) -5 kWh</p>
(3), (5)	<p>When integration stops, the output voltage at that point in time is held. When integration is started in that state, the voltage continues to change from the held output voltage.</p>
(7)	<p>When integration stops, level output is in the integration stopped state. The output voltage at this point is held.</p>
(8)	<p>When integrated values are reset, the output voltage changes to 0 V. When integration is started in that state, the voltage changes from 0 V according to the integrated value and is output.</p>

Time average current/ active power

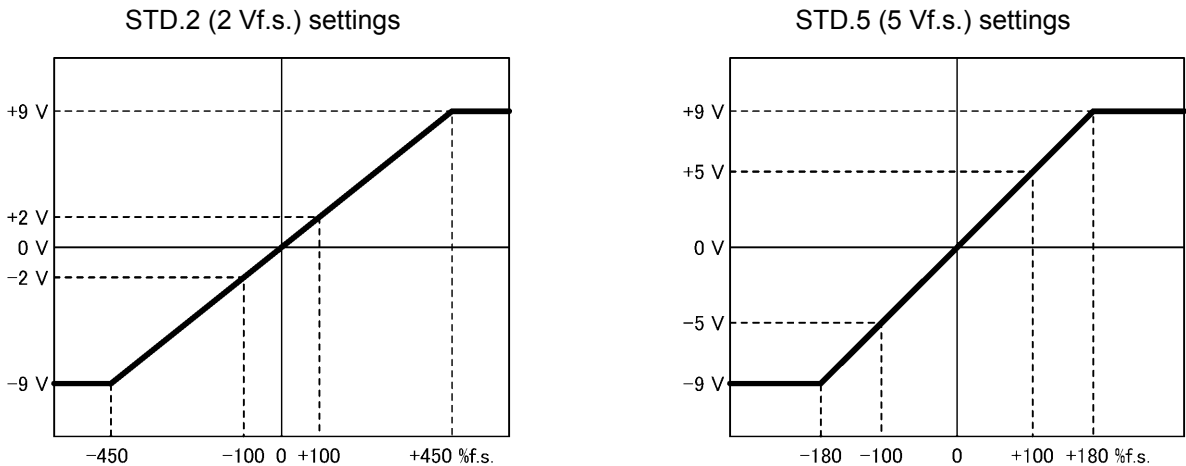

The f.s. for level output for time-average current and time-average active power is the current or active power measurement range, and level output changes to +9 V at $\pm 450\%$ f.s. when using STD.2 (2 V) or at $\pm 180\%$ f.s. when using STD.5 (5 V), voltages in excess of that value are not output.

Output voltage of waveform output

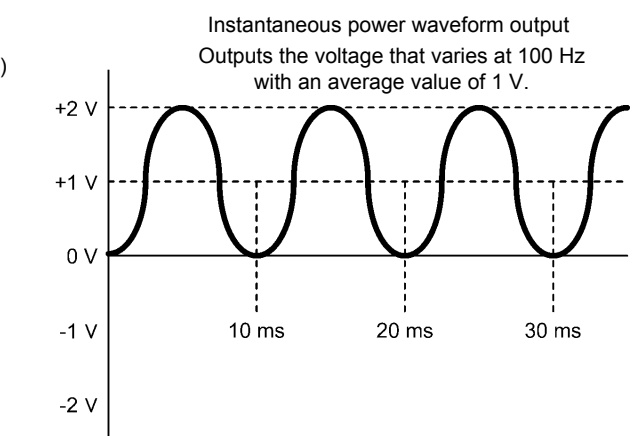
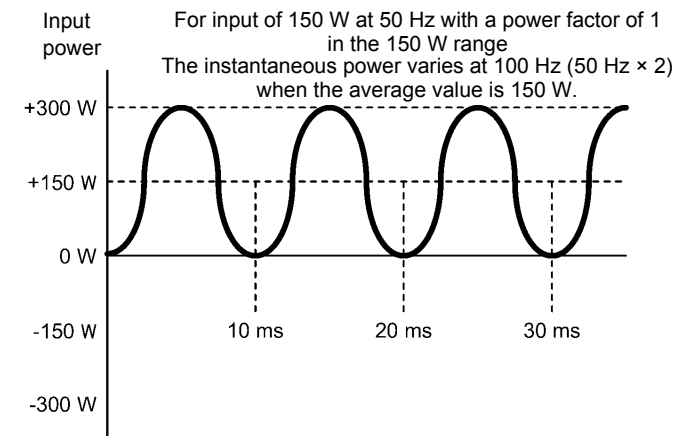
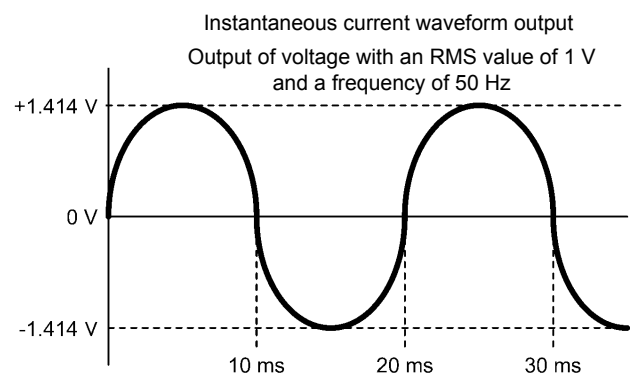
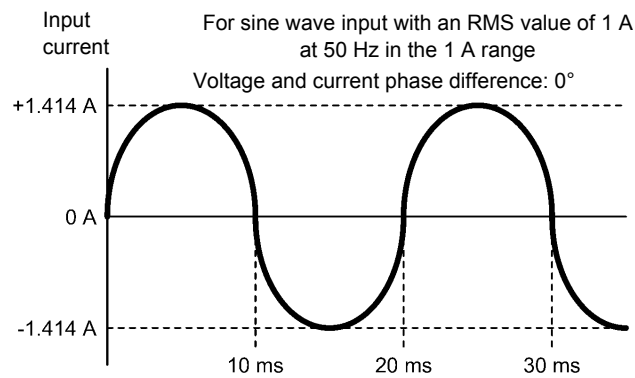
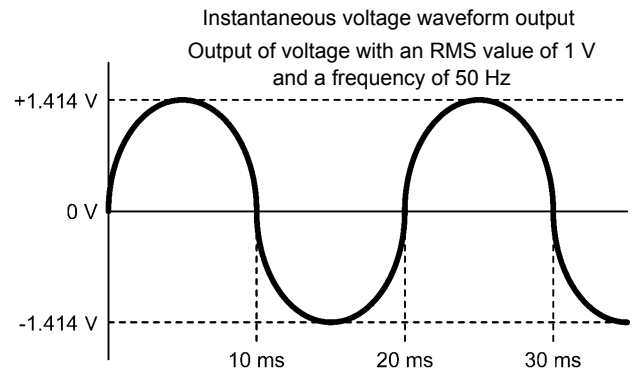
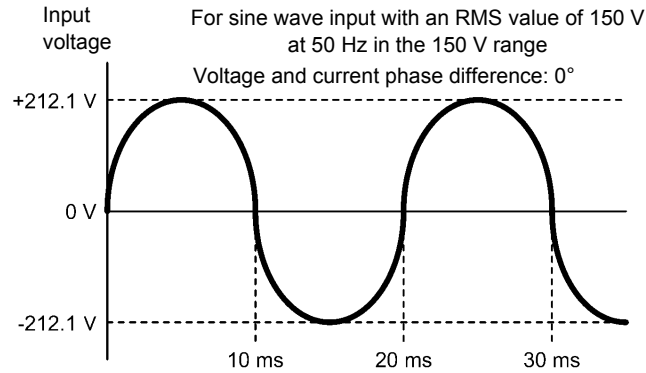

3.8 Using a Current Sensor

PW3335-03

PW3335-04

An optional current sensor can be used to measure currents in excess of the instrument's current effective measurement range maximum of 30 A. By setting the instrument's CT ratio based on the rating of the current sensor being used, it is possible to read the CT's primary-side current value directly. (p.58)



The external current sensor input terminals are not isolated (secondary potential). Never connect any input other than isolated input from an optional current sensor to the terminals. Doing so may result in a short-circuit accident or electric shock.

The instrument can use the current sensors listed below. For detailed specifications for current sensors or the 9555-10 Sensor Unit as well as information about how to use the sensors, see the included instruction manual.

■ Current sensors (TYPE.1) that are connected directly to the instrument's external current sensor input terminals (current sensor terminals)

The following current sensors are referred to as "TYPE.1" current sensors:

- Model 9661 Clamp on Sensor (rated current: 500 A AC)
- Model 9669 Clamp on Sensor (rated current: 1000 A AC)
- Model 9660 Clamp on Sensor (rated current: 100 A AC)
- Model CT9667 Flexible Clamp on Sensor (rated current: 500 A/5000 A AC)

■ Current sensors (TYPE.2) that are connected to the instrument's external current sensor input terminals (current sensor terminals) using the 9555-10 Sensor Unit and L9217 Connection Cord

The following current sensors are referred to as "TYPE.2" current sensors:

- Model 9272-10 Clamp on Sensor (rated current: 20 A/200 A AC range switchable)
- Model 9277 Universal Clamp on CT (rated current: 20 A AC/DC)
- Model 9278 Universal Clamp on CT (rated current: 200 A AC/DC)
- Model 9279 Universal Clamp on CT (rated current: 500 A AC/DC)
- Model 9709 AC/DC Current Sensor (rated current: 500 A AC/DC)
- Model CT6862 AC/DC Current Sensor (rated current: 50 A AC/DC)
- Model CT6863 AC/DC Current Sensor (rated current: 200 A AC/DC)
- Model CT6865 AC/DC Current Sensor (rated current: 1000 A AC/DC)
- Model CT6841 AC/DC Current Probe (rated current: 20 A AC/DC)
- Model CT6843 AC/DC Current Probe (rated current: 200 A AC/DC)

Before connecting a current sensor

Please read "Operating Precautions" (p.5) carefully before connecting a current sensor to the instrument.



When the clamp sensor is opened, do not short-circuit two wires to be measured by bringing the metal part of the clamp into contact with them, and do not use over bare conductors.



- Do not connect or disconnect connection cords from the current sensor or 9555-10 Sensor Unit while the instrument is turned on. Doing so may damage the instrument, current sensor, or 9555-10 Sensor Unit.
- Do not input current to the current sensor when it is not connected to the instrument or when the instrument and 9555-10 Sensor Unit are turned off. Doing so may damage the current sensor, instrument, or 9555-10 Sensor Unit.
- Avoid stepping on or pinching cables, which could damage the cable insulation.
- Be careful to avoid dropping the current sensors or otherwise subjecting them to mechanical shock, which could damage the mating surfaces of the core and adversely affect measurement.
- Do not place the current sensor's core tips around foreign objects or insert foreign objects into the core slits. Doing so may degrade current sensor performance or prevent it from opening and closing properly.



- When connecting a current sensor to the instrument or 9555-10, disconnect the current sensor from the measurement target and verify that no current is being input.
- To prevent damage to the connector when disconnecting the current sensor from the instrument or the connection cord from the 9555-10, be sure to release the locking mechanism, grip the head of the BNC connector (not the cord), and pull it out.
- When using the 9555-10, use the L9217 Connection Cord (which is made of plastic). Using a metal BNC cable may damage the instrument's external current sensor input terminals (which are made of plastic) or the instrument.
- When not using a current sensor, place the clamp in the closed position. Storing the sensor with the clamp in the open position may allow dirt or dust to accumulate on the mating core surfaces, which could interfere with clamping action.
- When using external current sensor input terminals, disconnect any lines from the current input terminals. When using the current input terminals, disconnect any lines from the external current sensor input terminals.

- The instrument's settings can be used to switch between current input terminals (maximum input current of 30 A, ± 100 A peak) and external current sensor input terminals. Current signals input to input terminals that are not set as enabled are ignored.
- The instrument's CT ratio is set based on the current sensor type and rating. If the CT ratio is set improperly, it will be impossible to conduct accurate measurement.
- The measurement accuracy when using a current sensor is obtained by adding the instrument's external current sensor input measurement accuracy and the current sensor's measurement accuracy.
- Depending on the current sensor being used, the instrument's accuracy defined range may be narrower than the current sensor's frequency band.

Connecting a TYPE.1 current sensor

Connect the current sensor directly to one of the instrument's external current sensor input terminal.

- 1** Connect the current sensor's BNC connector to a external current sensor input terminal. Align the groove on the BNC connector with the connector guides on the instrument and insert.

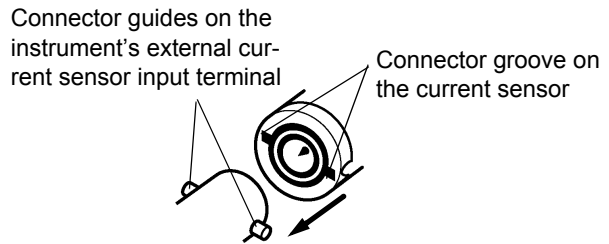
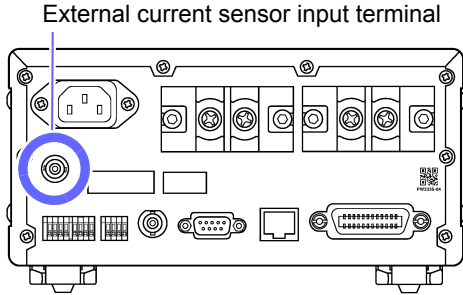

- 2** Turn clockwise to lock.

To remove the connector, turn it counterclockwise to disengage the lock and then pull out.

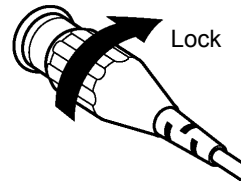

Connecting a TYPE.2 current sensor

Use the 9555-10 Sensor Unit and L9217 Connection Cord to input current sensor output to the instrument.

(Example connection)

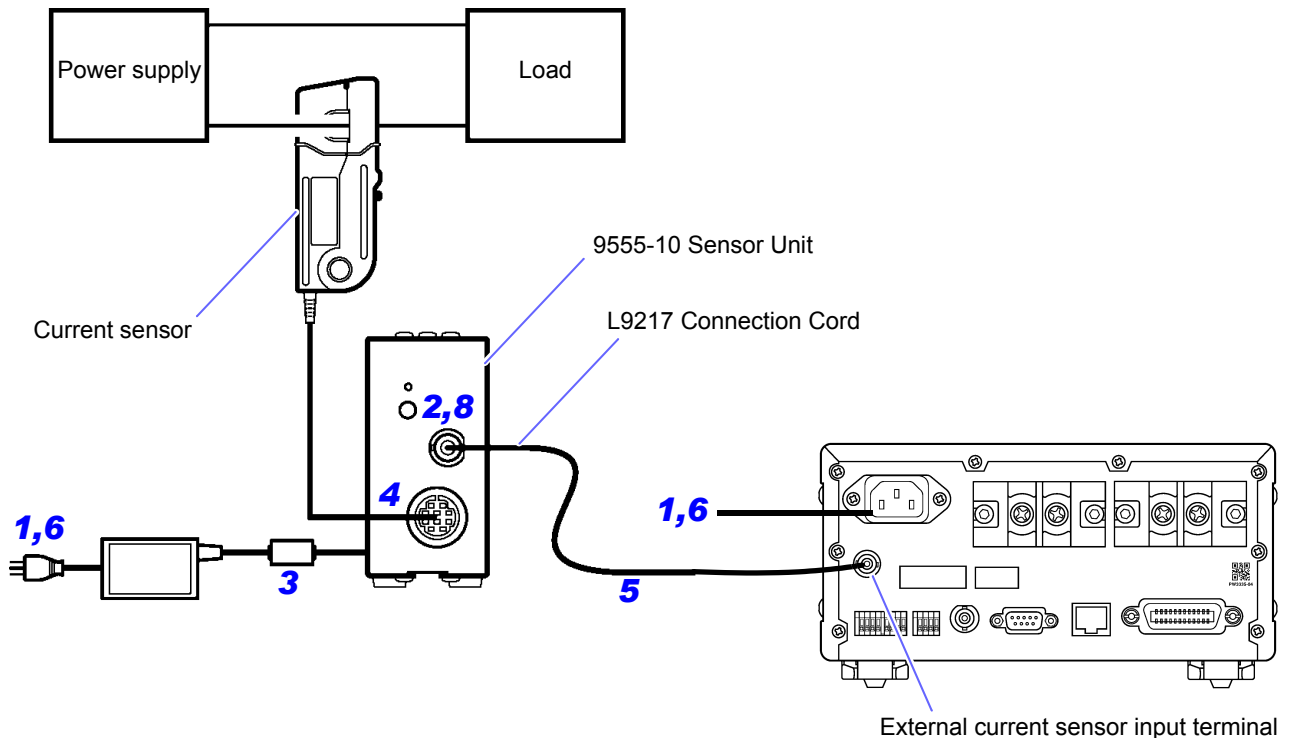

- 1** Verify that the instrument's power cord as well as the power cord for the AC adapter that came with the 9555-10 are unplugged from their outlets.
- 2** Verify that the instrument and 9555-10 have been turned off.
- 3** Connect the AC adapter that came with the 9555-10 and then connect the power cord to the AC adapter.

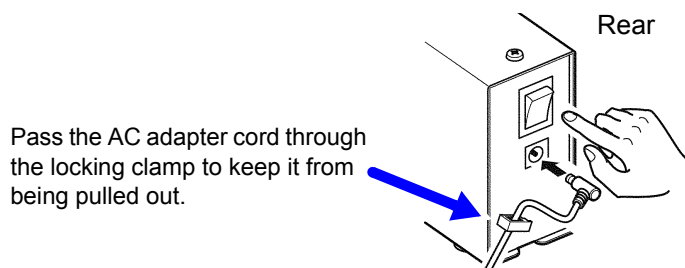

- 4** Connect the TYPE.2 current sensor you will use to the 9555-10's sensor connector.

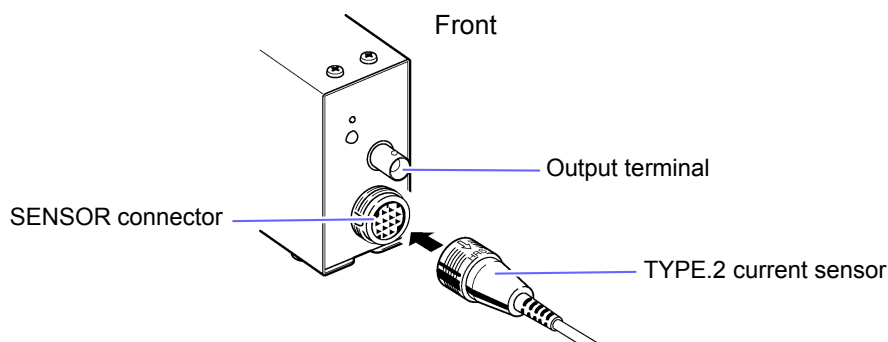

- 5** Connect the 9555-10's output terminal and one of the instrument's external current sensor input terminals (CURRENT SENSOR) with the L9217 Connection Cord.
- 6** Connect the power cord to the instrument and connect the instrument and 9555-10's power cords to outlets.
- 7** Turn on the instrument and verify that the display shows the Measurement screen.
- 8** Turn on the 9555-10 and verify that the current monitor lights up.

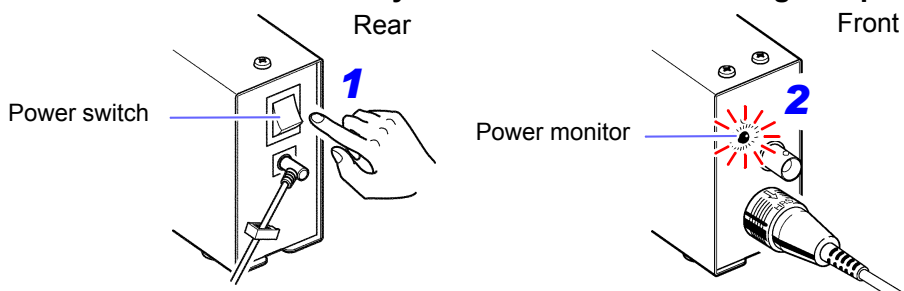

- If using the 9277, 9278, or 9279 Universal Clamp on CT, press the 9555-10's DEMAG switch to perform degaussing operation.
- When using the CT6841/CT6843 AC/DC Current Probe, perform zero-adjustment for the current sensor.
 1. Set the instrument to the 1 A range noted on the panel.
 2. Set the display parameter to A and the rectifier to DC.
 3. Turn the zero-adjustment knob (0ADJ) on the CT6841/CT6843 so that the display reads 0 A.
- When using the CT6841/CT6843, the following is added to the current sensor accuracy (by performing the above zero-adjustment procedure):
 - CT6841: ± 20 mA
 - CT6843: ± 200 mA

Setting external current sensor input

This section describes how to set the type of current sensor being used, the instrument's CT ratio, and the measurement range.

- See:** "3.2.1 Selecting the Current Input Method" (p.38)
 "3.2.8 Setting the VT Ratio and CT Ratio" (p.58)
 "3.2.3 Selecting the Voltage and Current Ranges" (p.43)

CAUTION



The instrument cannot automatically detect or set the current sensor type or CT ratio. When using a current sensor, you must set the current sensor type and CT ratio. If you replace the sensor with another unit that has a different rating, you must reconfigure the current sensor type and CT ratio.

- When the current sensor type is set to "Off," input from the current input terminals is enabled, and external current sensor input is ignored.
- The panel displays the current measurement ranges when using external current sensor input as 1 A, 2 A, and 5 A. When the auto-range setting is enabled, auto-range operation is performed among the 1 A, 2 A, and 5 A ranges noted on the panel.
- When using the 9660 Clamp on Sensor, use the 100 A range (shown as the 1 A range on the instrument's panel).

Current sensor types and instrument CT ratio settings

Current sensor	Current sensor rating	TYPE	CT ratio
Model 9661 Clamp on Sensor	500 A AC	1	100
Model 9669 Clamp on Sensor	1000 A AC	1	200
Model 9660 Clamp on Sensor	100 A AC	1	100
Model CT9667 Flexible Clamp on Sensor	500 A / 5000 A AC	1	100/ 1000
Model CT6862 AC/DC Current Sensor	50 A AC/DC	2	10
Model CT6863 AC/DC Current Sensor	200 A AC/DC	2	40
Model CT6865 AC/DC Current Sensor	1000 A AC/DC	2	200
Model 9709 AC/DC Current Sensor	500 A AC/DC	2	100
Model 9277 Universal Clamp on CT	20 A AC/DC	2	4
Model 9278 Universal Clamp on CT	200 A AC/DC	2	40
Model 9279 Universal Clamp on CT	500 A AC/DC	2	100
Model 9272-10 Clamp on Sensor	20 A / 200 A AC	2	4 / 40
Model CT6841 AC/DC Current Probe	20 A AC/DC	2	4
Model CT6843 AC/DC Current Probe	200 A AC/DC	2	40

When the measurement target's current exceeds the optional current sensor's rating

Use an external CT.

Using an external CT

DANGER



If energized components are exposed when connecting the current sensor, exercise care not to touch them or the CT. Doing so may result in electric shock, bodily injury, or a short-circuit accident.

WARNING



When using an external CT, avoid open-circuiting the secondary winding. If current flows through the primary when the secondary is open, high voltage across the secondary could present a dangerous hazard.

- The external CT's phase different could introduce a significant error component into power measurement. For more accurate power measurement, use a CT with a small phase error in the frequency band used by the circuit.
- When using an external CT, ground the CT's secondary negative terminal to ensure safety.

See: "Current sensor types and instrument CT ratio settings" (p.104)

Usage example

Measured current	7,800 A (7.8 kA)
Current sensor	Model 9669 Clamp on Sensor (rated current: 1,000 A AC)
External CT	10:1

Configure the instrument as follows:

Current sensor type: TYPE.1

CT ratio: 2,000 (current sensor's CT ratio of 200) × (external CT's CT ratio of 10)

Current measurement range: 10 kA (shown as 5 A range on the instrument's panel)

The current measured value (display value) on the instrument will be [7,800 kA].

3.9 Other Functions

3.9.1 Fixing Display Values (Display Hold)

You can hold the display of all measured values by pressing **HOLD** (placing the instrument in the display hold state).

Activating display hold

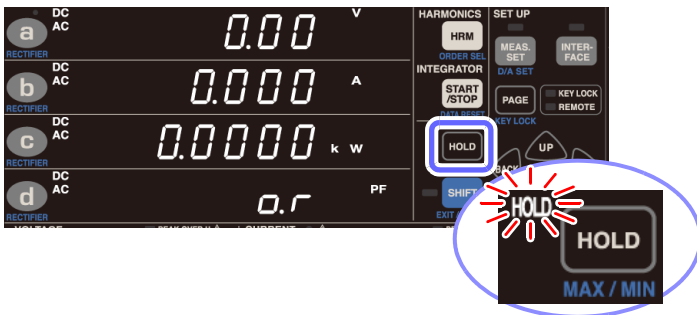

Press **HOLD**.

The display of measured values will be fixed when **HOLD** is pressed, and the **HOLD** lamp will light up.

Canceling the display hold state

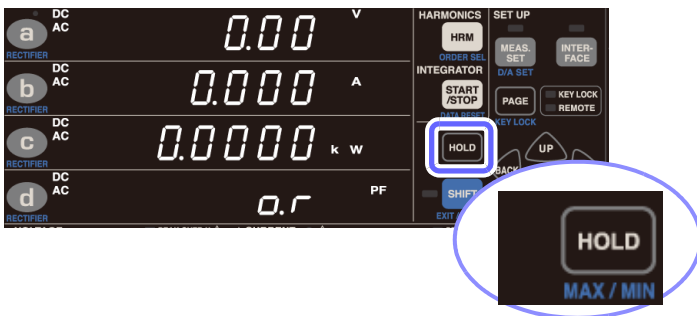

Press **HOLD** while the instrument is in the display hold state.

The instrument will return to the normal display (Measurement screen), and the **HOLD** lamp will turn off.

- The following operations are not available when in the display hold state:
 - Range switching
The instrument will display **[Err.16]** if any range key is pressed. (p.170)
Similarly, the range will not change during auto-range operation. The range will be fixed to the range in effect when the instrument was placed in the hold state.
(The range can be switched while auto-range integration is in the stopped state.)
 - Setting changes (integration time, number of averaging iterations, VT ratio, CT ratio, etc.)
The setting parameter will light up on the Settings screen, and you will not be able to change it.
 - The flashing cursor cannot be moved to parameters that cannot be changed while in the hold state.
- To change a setting, press the **HOLD** to cancel the display hold state (so that the **HOLD** lamp turns off).

The display hold will be unavailable in the following condition:

- During the **AVG** lamp is blinking
The display hold will become available when the **AVG** lamp that has been blinking lights up, which means that an average data is determined. Measurement values that are not supposed to be averaged such as a peak value will not be subject to the display hold until an average data is determined.
- Immediately after the setting such as the range is changed (while **[- - - -]** is shown on the display)
The display hold will become available when a measurement value appears on the display on which **[- - - -]** has been shown.

3.9.2 Displaying Maximum, and Minimum Values (MAX/MIN)

The instrument continuously measures instantaneous, maximum, and minimum values. The display can be switched to these values with the **HOLD** key.

- The maximum value (including waveform peak value) for each measurement parameter is detected and held on the display. (maximum value hold).
- The minimum value (including waveform peak value) for each measurement parameter is detected and held on the display. (minimum value hold).

Switching the display among the maximum, minimum, and instantaneous values

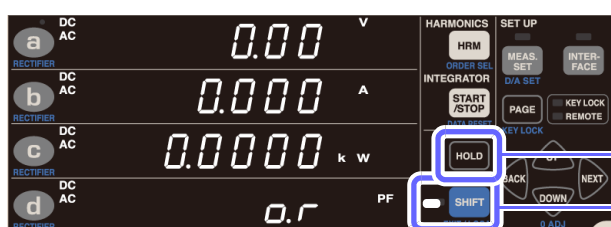

1 Press **SHIFT** to place the instrument in the shift state.

2 Press **HOLD**.
MAX / MIN

The **MAX** lamp will turn on, and the display will switch to the maximum value display.



3 Press **HOLD** again.
MAX / MIN

The **MIN** lamp will turn on, the display will switch to the minimum value display.



4 Press **HOLD** again.
MAX / MIN

The **MIN** lamp will turn off, return to the instantaneous value display.



To display the maximum value again, repeat the process from step **1**.

Clearing maximum and minimum values



Pressing **START / STOP** after pressing **SHIFT** to place the instrument in the SHIFT state will clear the maximum and minimum values and restart their measurement. Maximum and minimum values are also cleared, and their measurement restarted, at the start of integration.

- The following operations are not available when in the maximum value or minimum value hold state:
 - Setting changes (integration time, number of averaging iterations, VT ratio, CT ratio, etc.)
The setting parameter will light up on the Settings screen, and you will not be able to change it.
 - The flashing cursor cannot be moved to parameters that cannot be changed while in the hold state.
- To change a setting, press **HOLD** to return to the instantaneous value display.
- For parameters other than waveform peak values, the maximum and minimum values are compared using the absolute values of measured values. For waveform peak values, the maximum value for the waveform is shown as the maximum value, and the minimum value of the waveform is shown as the minimum value.
- For integration times, integrated values, and time average values, no maximum values or minimum values are determined. For integration times and integrated values, instantaneous values are directly displayed. For time averages, [- - - -] is displayed.

3.9.3 Disabling Control Keys (Key Lock)

Control keys can be disabled (by placing the instrument in the key lock state) to prevent inadvertent operation during measurement.

Enabling the key lock state

The instrument will not accept key lock input while the **KEY LOCK** lamp is lit up.



1 Press **SHIFT** to place the instrument in the shift state.

2 Press **PAGE** .
KEY LOCK

The instrument will enter the key lock state, and the **KEY LOCK** lamp will light up.



Canceling the key lock state



1 Press **SHIFT** to place the instrument in the shift state.

2 Press **PAGE** .
KEY LOCK

The control keys will be enabled, and the **KEY LOCK** lamp will turn off.



- When there are communications over one of the instrument's interfaces while in the key lock state, the **KEY LOCK** lamp will flash, and the instrument will enter the remote state (the **REMOTE** lamp will light up).
- While in the remote state, keys are disabled.
- To enable use of the control keys, press **SHIFT** to cancel the remote state.

EXIT / LOCAL

See: "4.3 Canceling the Remote State (Activating the Local State)" (p.137)

3.9.4 Initializing the Instrument (System Reset)

This section describes how to initialize the instrument's settings. Initializing the instrument (performing a system reset) reverts settings to their default values at the time the device was shipped from the factory. The system reset should be performed while the self-test is in progress after turning on the instrument (before the display changes to the normal display).

- Disconnect any voltage or current input from the instrument before performing the reset.
- The RS-232C communications speed, GP-IB address, LAN-related settings, and LR8410 Link will not be initialized.

Example: PW3335-03

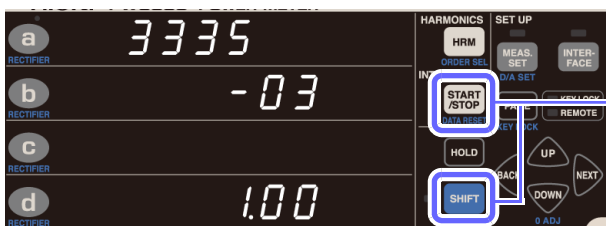

- 1 Turn on the instrument.
- 2 While the product model and version are being displayed, press

SHIFT and then **START/STOP**.

DATA RESET

(The **SHIFT** lamp will not light up.)



The System Reset screen will be displayed, and settings will be reverted to their default values when the instrument was shipped from the factory.

Factory Settings

Parameter	Setting
Display area a	AC+DC V
Display area b	AC+DC A
Display area c	AC+DC kW
Display area d	AC+DC PF
Voltage range	300 V range (auto-range off)
Current range	20 A range (auto-range off)
Synchronization source	U
Current input PW3335-03 PW3335-04	Direct input (off)
VT ratio	1 (OFF)
CT ratio	1 (OFF)
Frequency measurement range (zero-cross filter)	500 Hz
Timeout	0.1 sec.
Integration time	0000.00 (10,000 hr.)
Auto-range integration	OFF
Number of averaging iterations (AVG)	1 (OFF)
Harmonic analysis upper limit order	50th
External synchronization function	OFF
Range select	All ranges on
Zero-cross threshold level	1% for all ranges
D/A output PW3335-02 PW3335-04	DA1 V: AC+DC, STD2 DA2 A: AC+DC, STD2 DA3 W: AC+DC, STD2 DA4 PF: AC+DC, STD2 DA5 V: AC+DC, FAST DA6 A: AC+DC, FAST DA7 W: AC+DC, FAST
Integration	Reset state
Display hold	OFF
Maximum value/minimum value display	OFF
Key-lock	OFF
LAN-related settings	IP address: 192.168.1.1 Subnet mask: 255.255.255.0 Default gateway: 0.0.0.0
RS communications speed PW3335 PW3335-02 PW3335-03 PW3335-04	38,400 bps
GP-IB address PW3335-01 PW3335-04	1
LR8410 Link PW3335 PW3335-02 PW3335-03 PW3335-04	PC

LAN, RS-232C, GP-IB, and LR8410 Link settings will not be initialized when a system reset is performed.

3.10 When warning lamp, o.r, or the Unit Indicator Flashes

3.10.1 If the PEAK OVER U or PEAK OVER I Lamp Lights Up



These lamps will light up if the voltage input or current input waveform peak value exceeds the figures listed below. At this time, the displayed data is not accurate.

- Voltage input waveform peak value: $\pm 600\%$ of the voltage range
When using the 300 V, 600 V, or 1,000 V range, $\pm 1,500$ V peak
- Current input waveform peak value: $\pm 600\%$ of the current range
When using the 20 A range, ± 60 A peak

Error display	Status	Solution
PEAK OVER U	When greater than $\pm 1,500$ V peak	Stop measurement immediately, deactivate power to measurement lines, and disconnect wires.
	When less than $\pm 1,500$ V peak	The internal circuit is not operating properly. Switch to a range for which the PEAK OVER U lamp does not light up. See: "3.2.3 Selecting the Voltage and Current Ranges" (p.43)
PEAK OVER I	When greater than ± 60 A peak	Stop measurement immediately, deactivate power to measurement lines, and disconnect wires.
	When less than ± 60 A peak	The internal circuit is not operating properly. Switch to a range for which the PEAK OVER I lamp does not light up. See: "3.2.3 Selecting the Voltage and Current Ranges" (p.43)

3.10.2 If the CURRENT ● Lamp Flashes

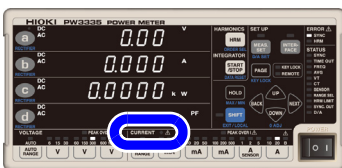

Status	Operation	Solution
<p>Forcibly changes the range to the 200 mA range if current of greater than or equal to ± 612 mA peak is inputted continuously for 10 or more seconds when using a range from 1 mA to 100 mA with fixed range, and the CURRENT ● lamp will flash.</p> <p>* If the 200 mA range has been disabled using the range select function, the range will be switched to an enabled range greater than the 200 mA range.</p>	<p>Integration will be forcibly stopped (causing the RUN lamp to flash), and it will not be possible to resume integration operation.</p>	<p>Instrument protection mode can be canceled by performing any of the following actions, causing the CURRENT ● lamp to turn off:</p> <ul style="list-style-type: none"> • Pressing one of the current range keys • If integration has stopped, resetting integrated values • If integration has been reset, pressing SHIFT key <small>EXIT / LOCAL</small> • Performing a system reset • Performing zero-adjustment (Available only in the integration reset state) • Turning the instrument off, and then on again (integrated values will be reset)

3.10.3 When o.r (over-range) Is Displayed



This indication is displayed when the voltage or current exceeds 152% of the range. When using the voltage 1,000 V range, it is displayed when 1,060.5 V is exceeded.

For active power, [o.r] is not displayed until the 231.04% of the power range is exceeded, even if the voltage or current reading is shown as [o.r]. The [o.r] indication is displayed for parameters calculated using [o.r] data.

The [o.r] indicator is displayed under the following conditions:

Apparent power	When [o.r] is displayed for either the voltage or current
Reactive power	When [o.r] is displayed for the voltage, current, or active power
Power factor	<ul style="list-style-type: none"> • When [o.r] is displayed for apparent power • When the apparent power is 0
Phase angle	When [o.r] is displayed for the power factor
Frequency measurement	When the reading falls outside the measurement range of 0.1 Hz to 100 kHz
Voltage waveform peak value	When the reading exceeds 102% of the voltage peak range
Current waveform peak value	When the reading exceeds 102% of the current peak range
Voltage crest factor	<ul style="list-style-type: none"> • When [o.r] is displayed for the voltage waveform peak value • When [o.r] is displayed for the voltage, or the voltage is 0
Current crest factor	<ul style="list-style-type: none"> • When [o.r] is displayed for the current waveform peak value • When [o.r] is displayed for the current, or the voltage is 0
Voltage ripple rate	<ul style="list-style-type: none"> • When [o.r] is displayed for the voltage waveform peak value • When [o.r] is displayed for the DC voltage, or the DC voltage is 0
Current ripple rate	<ul style="list-style-type: none"> • When [o.r] is displayed for the current waveform peak value • When [o.r] is displayed for the DC current, or the DC current is 0
Maximum current ratio	<ul style="list-style-type: none"> • When the power factor is 0 • When [o.r] is displayed for the current crest factor

Status	Solution
When [o.r] is displayed for the voltage	Switch to a range that does not result in an over-range condition. When [o.r] has been displayed while using the 1,000 V range, stop measurement immediately, deactivate power to measurement lines, and disconnect wires. See: "3.2.3 Selecting the Voltage and Current Ranges" (p.43)
When [o.r] is displayed for the current	Switch to a range that does not result in an over-range condition. When [o.r] has been displayed while using the 20 A range, stop measurement immediately, deactivate power to measurement lines, and disconnect wires. See: "3.2.3 Selecting the Voltage and Current Ranges" (p.43)

3.10.4 When the Unit Indicator Flashes



Status	Solution
The unit indicator flashes while displaying the average	The average value being displayed contains [o.r] data. If no [o.r] data is present during averaging processing, the unit indicator will not flash. When [o.r] is displayed, internal data for which the voltage or current exceeded 152% of the range, or the active power exceeded 231.04% of the range, will be used as-is in calculating the average value.
The integrated value or time average value unit indicator flashes (TOTAL and T.AV also flash)	Reset integrated values, change the range, and repeat integration. If no PEAK OVER condition occurs during integration, the indicator will not flash. See: "3.3 Integration" (p.61)

3.11 Connecting the Instrument to Hioki LR8410 Link compatible Logger

PW3335 PW3335-02 PW3335-03 PW3335-04

Measured values for the instrument's D/A output parameters can be sent wirelessly to an LR8410 Link compatible logger (LR8410, LR8416) using Bluetooth®. LR8410 Link compatible loggers can record measured values from the instrument at the same time as multichannel voltage, temperature, and humidity data.

The following Bluetooth® serial conversion adapter is required in order to connect the instrument to an LR8410 Link compatible logger:

Bluetooth® serial conversion adapter: Parani-SD1000 (from Sena Technologies Inc.)
Bluetooth® Class 1



To prevent electric shock or a short-circuit, verify that power to the measurement lines has been disconnected before connecting the Bluetooth® serial conversion adapter to an instrument that is connected to measurement lines.

- Check the instrument's RS-232C communications speed before using the adapter (9600bps/38400bps).
See: " Setting the RS-232C communications speed" (p.128)
- To ensure safety, be sure to turn off the instrument before connecting it to the adapter. Turn on the instrument after connecting the adapter.
- Refer to the Parani-SD1000 operating precautions for more information about Bluetooth® use.
- Because values are displayed at the resolution of the logger being used, they will differ slightly from the measured values that are displayed by the instrument. To record values that are closer to the instrument's measured values, choose a range that is appropriate for the input.
- For more information about how to configure Hioki LR8410 Link compatible loggers such as the LR8410, see the instruction manual for the logger with which you wish to use the instrument.
- Do not subject the Bluetooth® serial conversion adapter to mechanical shocks while it is connected to the instrument. Doing so may damage the adapter.
- When using the instrument's stands, exercise care to ensure that the Bluetooth® serial conversion adapter does not come into contact with the surface on which the instrument is sitting.
- Do not send communications commands to the instrument while it is connected with LR8410 Link. Doing so may cause the instrument to malfunction, for example by interrupting communications.

Configuring and connecting the adapter

- 1** Verify that the instrument is turned off.
- 2** Set the communications speed for the Bluetooth® serial conversion adapter (9600 bps/38400 bps).
Set using the DIP switches on the adapter.
- 3** Connect the Bluetooth® serial conversion adapter to the instrument's RS-232C connector (9-pin D-sub connector) and turn the switch on the side of the adapter to "ON."
- 4** Turn on the instrument.

Configuring the instrument

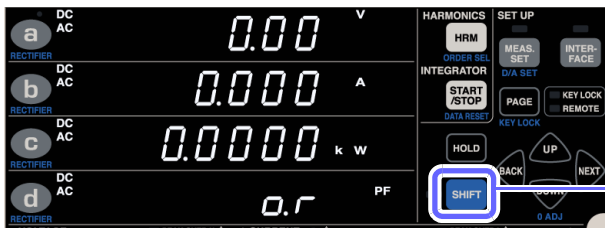

1 Press **SHIFT** to activate the SHIFT state.

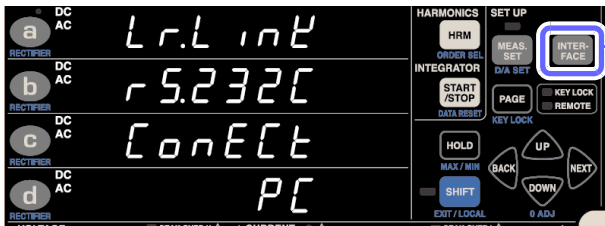

2 Press **INTER-FACE** to display the LR8410 Link settings screen. (Display area a will indicate [Lr.Link].)

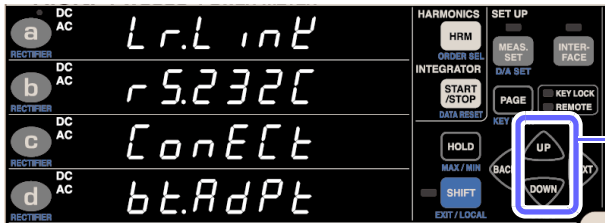

3 Press **UP** or **DOWN** to set display area d to [bt.AdPt].

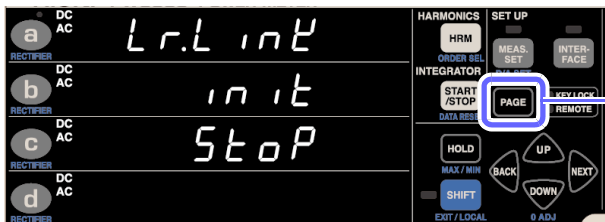

4 Press **PAGE** to display the Bluetooth® serial conversion adapter initialization screen.

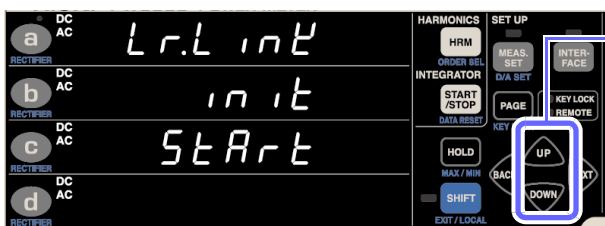

5 Press **UP** or **DOWN** to start the initialization process.

Wait for display area d to indicate [PASS] or [FAIL].

3.11 Connecting the Instrument to Hioki LR8410 Link compatible Logger

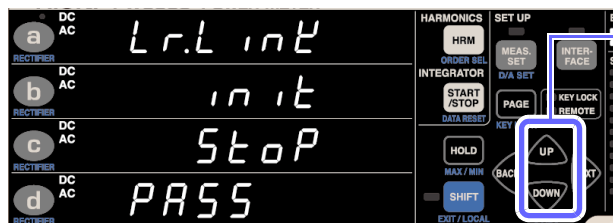

6 will indicate [PASS], and the initialization process will complete.

If the display indicates [FAIL], check the settings.

See: "6.2 Error Indication" (p.170)



7 Press **SHIFT** or **INTER-FACE** to exit the configuration process.

Default settings

Device name	PW3335#nnnnnnnn:HIOKI (where n indicates the 9-digit serial number)
Operation mode	Mode3 (Causes the adapter to stand by for connections from all Bluetooth® devices.)
Pin code	0000
Response	Unused
Escape sequence characters	Not permitted

- When using an LR8410 Link compatible logger to automatically save measured values from the instrument, it will not be possible to save accurate measured values if the instrument's measurement range is changed while automatic saving is enabled. Set the instrument's measurement range to an appropriate setting before connecting to the LR8410. Do not use auto-range integration.
- The following parameters can be output to an LR8410 Link compatible logger:

See: "3.7.1 Level Output, High-speed Level Output, and Waveform Output" (p.88)

Terminal	LR8410 Link output parameters		
	PW3335-02 PW3335-04 (with D/A output and RS-232C)	PW3335 PW3335-03 (without D/A output / with RS-232C)	PW3335-01 (without D/A output and RS-232C)
DA1	Same as D/A output	V: AC + DC (fixed)	Not available
DA2	Same as D/A output	A: AC + DC (fixed)	Not available
DA3	Same as D/A output	W: AC + DC (fixed)	Not available
DA4	Same as D/A output	PF: AC + DC (fixed)	Not available
DA5	Same as D/A output	Not available	Not available
DA6	Same as D/A output	Not available	Not available
DA7	Same as D/A output	Not available	Not available

- Only the equivalent of level output (updated every 200 ms) is available for output to LR8410 Link compatible loggers. High-speed level output and waveform output are not available.
- The instrument will enter the remote state (with the **REMOTE** indicator illuminated) when it starts communicating with the logger. To operate the instrument using its keys, do either of the following:
 - Cancel the pairing with the instrument in the logger settings and press the instrument's **SHIFT** key to place it in the local state (so that the **REMOTE** indicator is no longer illuminated)
 - Turn off the instrument and turn it back on after placing the switch on the side of the adapter in the "OFF" position.

Connection to a PC

Chapter 4

You can use the instrument's standard LAN interface to connect it to a computer, which can then control it remotely. Additionally, you can also control the instrument with communications commands using the LAN, RS-232C (optional feature), or GP-IB (optional feature) interface or transfer measurement data to a computer with a dedicated application software*. To use communications features, you must configure the communications conditions on the instrument.

* The latest version can be downloaded from our web site.



- Use a common ground for both the instrument and the computer. Use of different ground circuits will result in a potential difference between the instrument's ground and the computer's ground. If the communications cable is connected while such a potential difference exists, it may result in equipment malfunction or failure.
- Before connecting or disconnecting any the communications cable, always turn off the instrument and the computer. Failure to do so could result in equipment malfunction or damage.
- After connecting the communications cable, tighten the screws on the connector securely. Failure to secure the connector could result in equipment malfunction or damage.

- For more information about how to control the instrument using communications commands, see the Communications Command Instruction Manual*.
 - * The latest version can be downloaded from our web site.
- Use the LAN, RS-232C, or GP-IB interface. Using multiple interfaces simultaneously may cause the instrument to malfunction, for example by interrupting communications.
- Do not send communications commands to the instrument while it is connected with LR8410 Link. Doing so may cause the instrument to malfunction, for example by interrupting communications.

■ Using the LAN Interface (p.120)

- You can control the instrument remotely with an Internet browser. (p.134)
- You can control the instrument using communications commands (see the Communications Command Instruction Manual).
- You can control the instrument by creating a program and connecting to its communications command port via TCP.

■ Using the RS-232C Interface PW3335 PW3335-02 PW3335-03 PW3335-04 (p.127)

- You can control the instrument using communications commands (see the Communications Command Instruction Manual).
- Power is supplied to RS-232C devices that support 9-pin power supply (voltage of +5 V and maximum current of 200 mA).

■ Using the GP-IB Interface PW3335-01 PW3335-04 (p.131)

- You can control the instrument with communications commands (see the Communications Command Instruction Manual).

4.1 Configuring and Connecting the Instrument

4.1.1 Using the LAN Interface

You can control the instrument remotely with an Internet browser on a computer (p.134) or use command communications. Before doing so, you must configure the instrument's LAN settings and connect it to the computer with a LAN cable.

Use the LAN, RS-232C, or GP-IB interface. Using multiple interfaces simultaneously may cause the instrument to malfunction, for example by interrupting communications.

Items to verify before configuring settings and connecting to the instrument

- Always make LAN settings before connecting to the network. If you change settings while connected to the network, IP addresses may overlap or invalid address data may flow over the network.
- The instrument does not support networks on which the IP address is automatically acquired using DHCP.

IP address	Identifies each device connected on a network. Each network device must be set to a unique address. The instrument supports IP version 4, with IP addresses indicated as four decimal octets, example:, "192.168.0.1".
Subnet mask	This setting is for separating the IP address into the network address that indicates the network and the host address that indicates the instrument. On this instrument, the subnet mask is represented as four decimal numbers separated by "." such as "255.255.255.0".
Default Gateway	When the computer and instrument are on different but overlapping networks (subnets), this IP address specifies the device to serve as the gateway between the networks. If the computer and instrument are connected one-to-one, no gateway is used, and the instrument's default setting "0.0.0.0" can be kept as is.

When Connecting the instrument to an Existing Network

The following items must be assigned in advance by your network administrator. Be sure that there is no conflict with other devices.

IP address	_____ . _____ . _____ . _____
Subnet mask	_____ . _____ . _____ . _____
Default Gateway	_____ . _____ . _____ . _____

Connecting multiple instruments to a single computer using a hub

When building a local network with no outside connection, the following private IP addresses are recommended. Example settings: When creating a network with a network address of 192.168.1.0/24

IP address	Computer:192.168.1.1
Instrument:	Assign in order: 192.168.1.2, 192.168.1.3, 192.168.1.4, ...
Subnet mask	255.255.255.0
Default Gateway	0.0.0.0

Connecting one instrument to a single computer using the 9642 LAN Cable

The 9642 LAN Cable can be used with its supplied connection adapter to connect one instrument to one computer, in which case the IP address is freely settable. Use the recommended private IP addresses.

IP address	Computer: 192.168.1.1	Instrument: 192.168.1.2 (Set to a different IP address than the computer.)
Subnet mask	255.255.255.0	
Default Gateway	0.0.0.0	

Setting the LAN's IP address

Before using the LAN, set the LAN's IP address.

1 Press **INTER-FACE**.

2 Press **PAGE** to switch to the LAN's IP address settings screen. ([iP] will be displayed in display area b.)

3 Press **BACK** or **NEXT** until the digit you wish to set in the display area c or d, which will start flashing.

4 Press **UP** or **DOWN** to set the IP address.

Setting range: **000** to **255**

5 Press **INTER-FACE** to exit the settings.

The screen shown to the left will be displayed while the LAN is initialized.

The instrument will return to the normal display (Measurement screen).

Setting the LAN's subnet mask

Before using the LAN, set the LAN's subnet mask.



1 Press **INTER-FACE**.

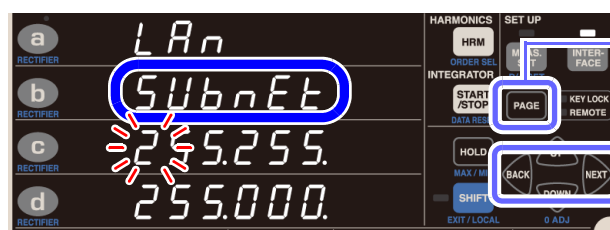

2 Press **PAGE** to switch to the LAN's subnet mask settings screen. ([**S**U**b**n**E**t]) will be displayed in display area **b**.)

3 Press **BACK** or **NEXT** until the digit you wish to set in the display area **c** or **d**, which will start flashing.

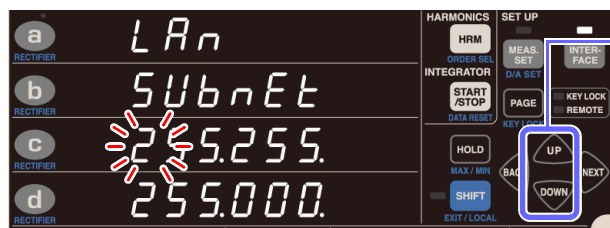

4 Press **UP** or **DOWN** to set the subnet mask.

Setting range: **000** to **255**

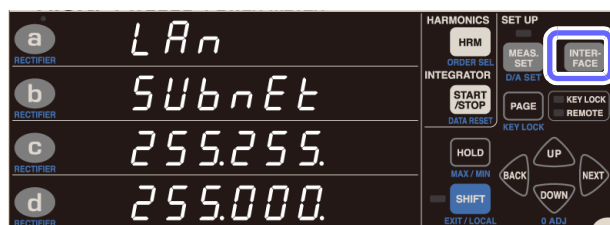

5 Press **INTER-FACE** to exit the settings.



The screen shown to the left will be displayed while the LAN is initialized.

The instrument will return to the normal display (Measurement screen).

Setting the LAN's default gateway

Before using the LAN, set the LAN's default gateway.



1 Press **INTER-FACE**.

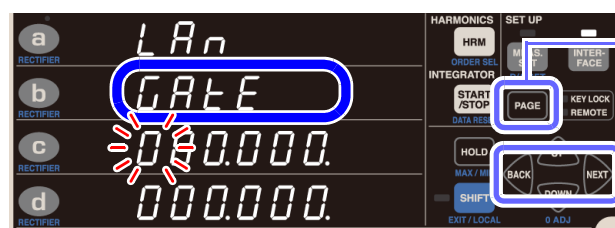

2 Press **PAGE** to switch to the LAN's sub-net mask settings screen. ([GATE] will be displayed in display area b.)

3 Press **BACK** or **NEXT** until the digit you wish to set in the display area c or d, which will start flashing.

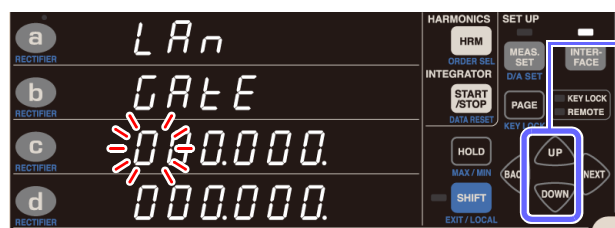

4 Press **UP** or **DOWN** to set the default gateway.

Setting range: **000** to **255**

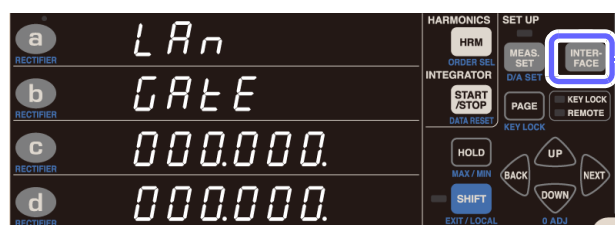

5 Press **INTER-FACE** to exit the settings.



The screen shown to the left will be displayed while the LAN is initialized.

The instrument will return to the normal display (Measurement screen).

Displaying the LAN's MAC address

You can check the instrument's MAC address.

The MAC address cannot be changed.

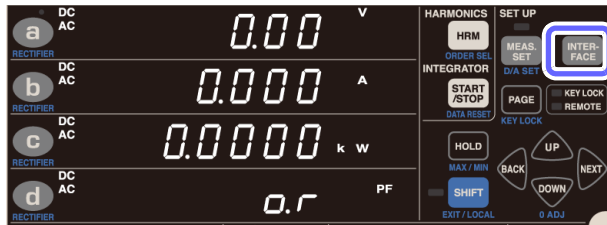

1 Press **INTERFACE**.

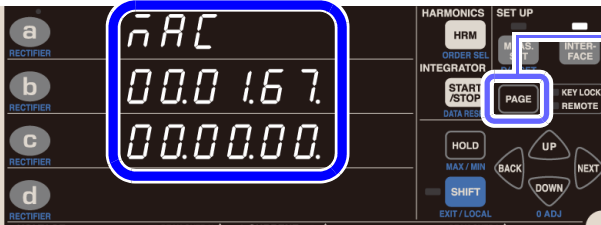

2 Press **PAGE** to display the MAC address. ([MAC] will be displayed in display area a.)

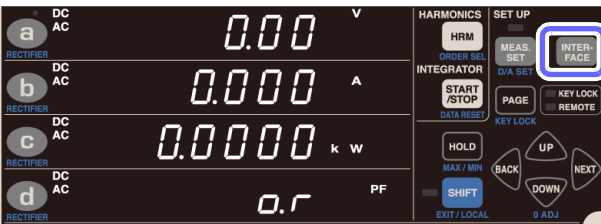

3 Press **INTERFACE**.

The instrument will return to the normal display (Measurement screen).

Connecting the instrument to a computer with a LAN cable

Connect the instrument and PC with a LAN cable.

There are two ways to accomplish this connection:

- Connect the instrument to an existing network.
- Connect the instrument to a single PC (p.126)

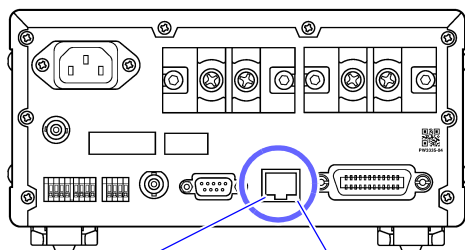

Orange LED

Lights up when the communications speed is 100 Mbps and turns off when the communications speed is 10 Mbps.

Green LED

Lights up when a link is established and flashes when communications are in progress.

1 Connect a LAN cable (that is compatible with 100BASE-TX) to the 100BASE-TX connector on the right side of the instrument.

2 Connect the LAN cable to the PC.

If the green LED fails to light up when the instrument is connected to a LAN, there may be an issue with the instrument, the device you are attempting to connect to the instrument, or the connection cable.

If, after reading "Troubleshooting (Communications)" in the Communications Command instruction Manual*, you think the instrument may be broken or malfunctioning, please contact your authorized Hioki distributor or reseller. If you think the device you are attempting to connect to the instrument may be broken or malfunctioning, please contact that device's manufacturer.

* The latest version can be downloaded from our web site.

Connecting the Instrument to a Network

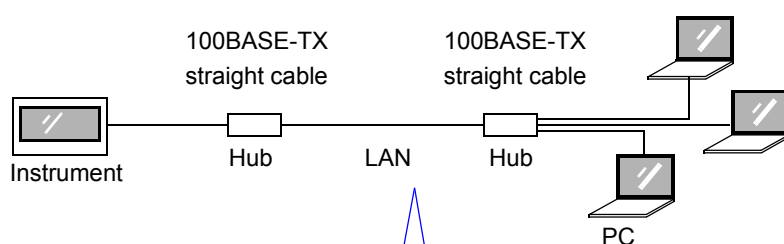

You can monitor and control the instrument from a PC by connecting the instrument to a hub with LAN cable (100BASE-TX cable).

Instrument's 100Base-TX connector

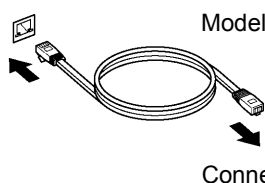

Model 9642 LAN Cable

Connect to hub

Connection cable: Use one of the following.

- 100BASE-TX straight-through cable (maximum length 100 m, commercially available)
- (10BASE-T cable may also be used for 10BASE communications)
- Model 9642 LAN cable (option)

Making Connections Between the Instrument and a PC

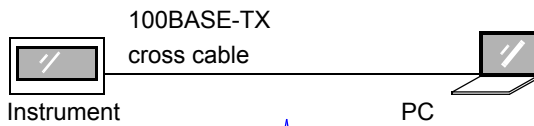

You can monitor and control the instrument from a PC by connecting the instrument to the PC with LAN cable (100BASE-TX cable)

Connecting with the 9642 LAN Cable and crossover adapter (supplied)

Connection cable: Use one of the following.

- 100BASE-TX crossover cable (maximum length 100 m)
- 100BASE-TX straight-through cable with crossover adapter (maximum length 100 m)
- 9642 LAN cable (option, supplied with crossover adapter)

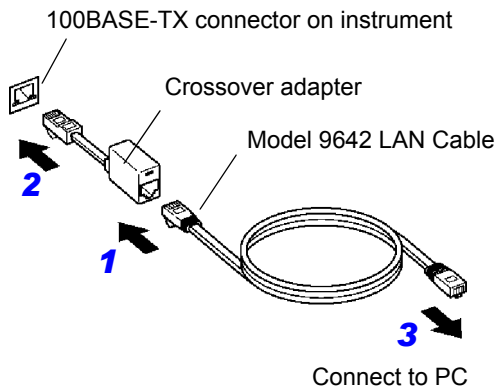

- 1** Connect the 9642 LAN Cable to the supplied crossover adapter.
- 2** Connect the crossover adapter to the 100BASE-TX connector on the instrument.
- 3** Connect the 9642 LAN Cable to the 100BASE-TX connector on the PC.

This completes the process of connecting the instrument and PC.

4.1.2 Using the RS-232C Interface

PW3335

PW3335-02

PW3335-03

PW3335-04

You can use the RS-232C interface to control the instrument using command communications.

Items to verify before configuring settings and connecting to the instrument

WARNING



• Always turn both devices OFF when connecting and disconnecting an interface connector. Otherwise, an electric shock accident may occur.

• Be sure to connect the cable to the target device's RS-232C connector. Connecting the cable to a connector with different electrical specifications may cause electric shock or equipment damage.



• To avoid damage to the instrument, do not short-circuit the terminal and do not input voltage to the terminal.

- Use the LAN, RS-232C, or GP-IB interface. Using multiple interfaces simultaneously may cause the instrument to malfunction, for example by interrupting communications.
- To connect a device that does not support power being supplied by the No. 9 pin, do not configure Bluetooth[®]. Doing so may damage the connected device.

See: "3.11 Connecting the Instrument to Hioki LR8410 Link compatible Logger" (p.115)

Specifications

Communication Method	Full duplex Start-stop synchronization
Communication Speed	9600bps/38400bps
Data Bits	8 bits
Parity	None
Stop bit	1 bit
Message terminator (delimiter)	During Receiving: LF During Sending: CR+LF (can be switched to LF)
Flow control	None
Electrical Specifications	Input voltage level 5 to 15 V : ON -15 to -5 V : OFF Output voltage level +5 V or greater : ON -5 V or less : OFF
Connector	Pin configuration of the interface connector (pin-contact 9-pin D-sub #4-40 attaching screws) The I/O connector is a DTE (Data Terminal Equipment) configuration. Recommended cable: <ul style="list-style-type: none"> • RS-232C Cable (for a computer) • 9638 RS-232C Cable (for a D-sub 25-pin connector) See: "Connecting the RS-232C Cable" (p.129) Note: When using a USB-serial converter to connect the instrument to a computer, you may need a gender converter (male/female adapter) and a straight-cross converter.

Code used: ASCII code

Setting the RS-232C communications speed



1 Press **INTERFACE**.



2 Press **PAGE** to switch to the LAN's subnet mask settings screen. ([rS.232C] will be displayed in display area a.)

3 Press **BACK** or **NEXT** until the display area **b** flashes.

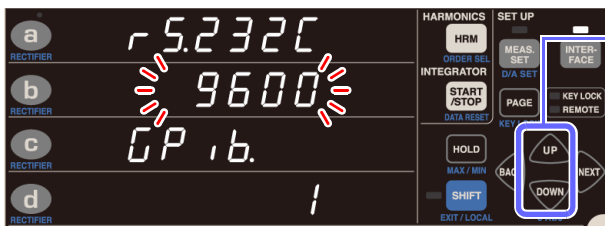

4 Press **UP** or **DOWN** to select the communications speed.

Default setting: 38400

Settings: **38400** → **9600**...

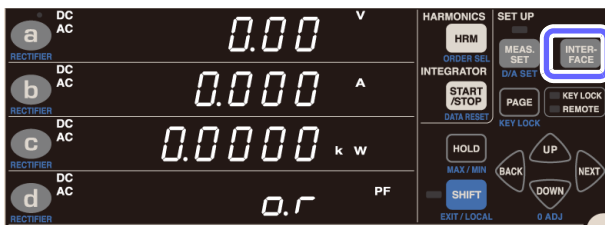

5 Press **INTERFACE** to exit the settings.

The instrument will return to the normal display (Measurement screen).

Connecting the RS-232C Cable

Recommended cable: Model 9637 RS-232C Cable (9pin-9pin/1.8 m crossover cable)

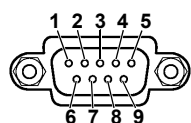
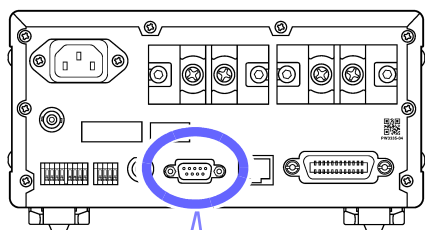

Pin-contact 9-pin D-sub
#4-40 attaching screws

1 Connect the RS-232C cable to the instrument's RS-232C connector.

Be sure to secure it in place with the screws.

2 Set the controller's communications protocol so that it is the same as the instrument's settings.

Configure the controller's settings as follows:

- Start-stop synchronization
- Communication Speed: 9,600 bps/ 38,400 bps (Use the same setting as the instrument.)
- Stop bit: 1 bit
- Data Bits: 8 bits
- Parity: None
- Flow control: None

- When connecting the instrument to a controller (DTE), use a cross cable that satisfies the specifications of the instrument's connector and the controller's connector.
- When using a USB-serial cable, you may need a gender converter and a straight-cross converter. Obtain models that satisfy the specifications for the instrument's connector and the USB-serial cable's connector.

The I/O connector is a DTE (Data Terminal Equipment) configuration.

Pin number 2, 3, 5, 7, and 8 are used in the instrument. The other pins are not used.

Pin No.	Interchange circuit name		CCITT circuit No.	EIA abbreviation	JIS abbreviation	Common abbreviation
1	Data/channel receive carrier detection	Carrier Detect	109	CF	CD	DCD
2	Received data	Receive Data	104	BB	RD	RxD
3	Transmitted data	Send Data	103	BA	SD	TxD
4	Data terminal ready	Data Terminal Ready	108/2	CD	ER	DTR
5	Signal ground	Signal Ground	102	AB	SG	GND
6	Data set ready	DATA Set Ready	107	CC	DR	DSR
7	Request to send	Request to Send	105	CA	RS	RTS
8	Clear to send	Clear to Send	106	CB	CS	CTS
9	Ring indicator	Ring Indicator	125	CE	CI	RI

4.1 Configuring and Connecting the Instrument

Computer

Use a crossover cable with socket-contact 9-pin D-sub connectors.

Recommended cable: Model 9637 RS-232C Cable (1.8 m, 9pin-9pin, crossover cable)

Crossover Wiring

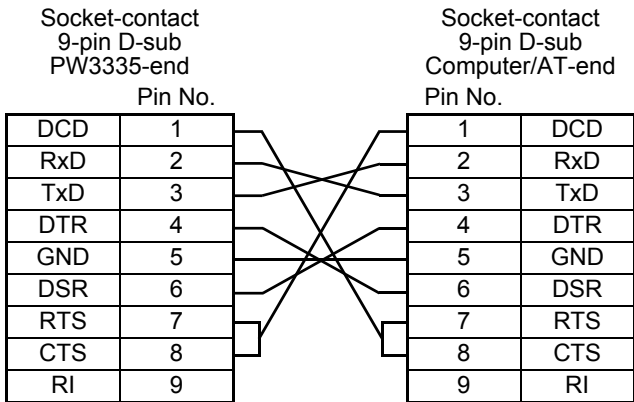

Device with D-sub 25-pin connector

Use a crossover cable with a socket-contact 9-pin D-sub and a pin-contact 25-pin D-sub connector.

As the figure shows, RTS and CTS pins are shorted together and crossed to DCD in the other connector.

Recommended cable: Model 9638 RS-232C Cable (1.8m, 25pin-9pin, crossover cable)

Crossover Wiring

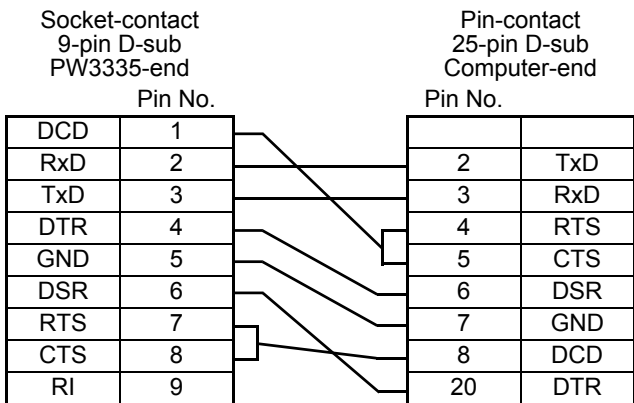

Note that the combination of a dual pin-contact 25-pin D-sub cable and a 9- to 25-pin adapter cannot be used.

4.1.3 Using the GP-IB Interface

PW3335-01

PW3335-04

You can use the GP-IB interface to control the instrument using command communications.

Items to verify before configuring settings and connecting to the instrument

WARNING



- Turn off all devices before connecting or disconnecting interface connectors. Failure to do so may result in electric shock.

- Be sure to connect the cable to the target device's GP-IB connector. Connecting the cable to a connector with different electrical specifications may cause electric shock or equipment damage.



- To avoid equipment damage, do not short-circuit the connector or input a voltage.

CAUTION



After connecting, be sure to tighten the connector screws. If the connector is not secured, operation may fail to meet specifications, and damage could result.

Use the LAN, RS-232C, or GP-IB interface. Using multiple interfaces simultaneously may cause the instrument to malfunction, for example by interrupting communications.

GP-IB

- Commands common to IEEE-488-2 1987 (requirement) can be used.
- The instrument complies with the following standard. (Compliance standard: IEEE-488.1 1987^{*1})
- The instrument has been designed with reference to the following standard. (Reference standard: IEEE-488.2 1987^{*2})

If the output queue becomes full, a query error will result, and the output queue will be cleared. Consequently, the instrument does not support the output queue clearing and query error output requirements in the deadlocked state^{*3} as defined by IEEE 488.2.

^{*1} ANSI/IEEE Standard 488.1-1987, IEEE Standard Digital Interface for Programmable Instrumentation

^{*2} ANSI/IEEE Standard 488.2-1987, IEEE Standard Codes, Formats, Protocols, and Common Commands

^{*3} Deadlocked state: A state in which processing cannot be continued because the input buffer or output buffer is full.

Specifications

SH1	Supports all source handshake functions.
AH1	Supports all acceptor handshake functions.
T6	Supports standard talker functions.Supports serial poll functions.Talk only mode is not supported.Supports the talker cancel function by MLA (My Listen Address).
L4	Supports standard listener functions.Listener only mode is not supported.Supports the listener cancel function by MTA (My Talk Address).
SR1	Supports all service request functions.
RL1	Supports all remote/local functions.
PP0	Parallel poll functions are not supported.
DC1	Supports all device clear functions.
DT1	Supports all device trigger functions.
C0	Controller functions are not supported.

Code used: ASCII code

Connecting the GP-IB Cable

Recommended cable: Model 9151-02 GP-IB connection cable (2 m)

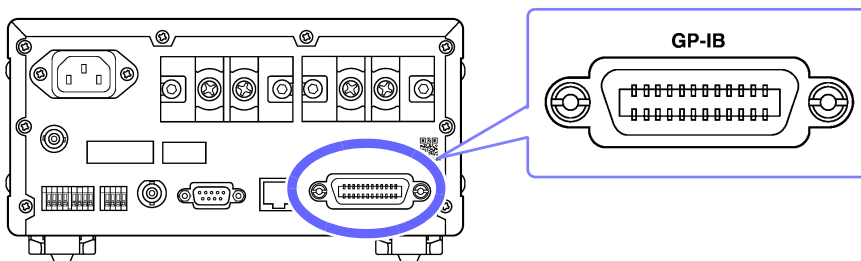

Connect the GP-IB cable to the GP-IB connector.

Be sure to secure it in place with the screws.

Setting the GP-IB address

Before using the GP-IB interface, you must set the GP-IB address.

1 Press **INTER-FACE**.

2 Press **PAGE** to switch to the GP-IB address settings screen. ([**GPib.**]) will be displayed in display area **c**.)

3 Press **BACK** or **NEXT** until the display area **d** flashes.

4 Press **UP** or **DOWN** to set the GP-IB address.
 Default setting: 1
 Setting range: **0** to **30**

5 Press **INTER-FACE** to exit the settings.
 The instrument will return to the normal display (Measurement screen).

4.2 Operating the Instrument from a PC's Browser (LAN only)

By connecting the instrument to a computer via a LAN, you can operate from the instrument using a PC Web browser such as Internet Explorer®.

It is recommended to use IE (Internet Explorer®) Version 9 or later.

Connecting and configuring the LAN port

See: "4.1.1 Using the LAN Interface" (p.120)

Enter the instrument's IP address as the Web browser's address field and press the **[Enter]** key to display the home screen.

Example: "http://192.168.1.2"

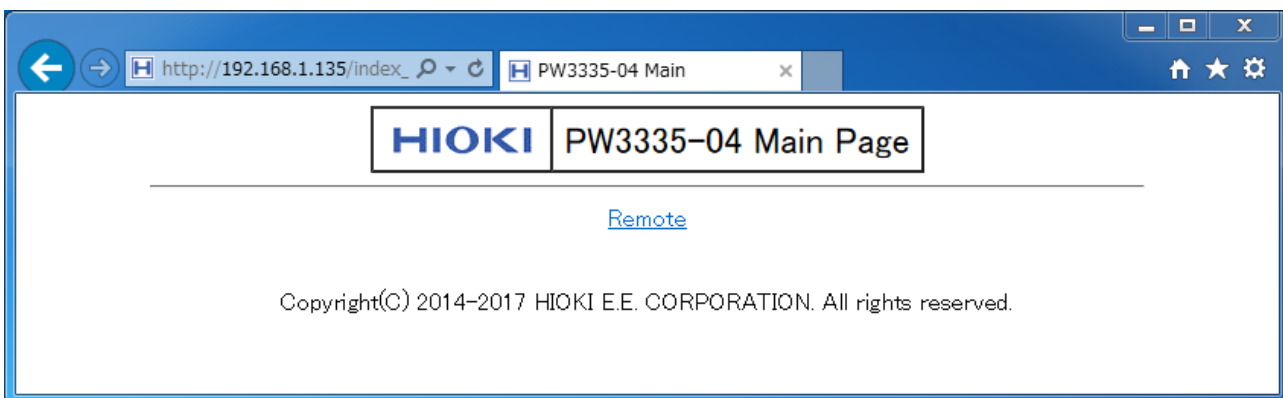

Operating the instrument remotely

Selecting **[Remote]** on the menu displays the Remote Operation screen. The screen shown on the instrument will be shown as-is in the browser window.

The buttons on the control panel correspond to the buttons on the instrument. You can also operate the instrument remotely by clicking the screen with the mouse (the same key operation as the instrument).

You can save a PNG-format screenshot by clicking the **[Screen copy]** button.

You can also zoom in and out on most browsers by using CTRL + "+" to zoom in, CTRL + "-" to zoom out, and CTRL + "0" to select normal size.

You can select how often the screen is updated (update speeds are about 0.3 sec **[High]**, 1 sec **[Normal]**, and 10 sec **[Low]**).

You can display a comment at the top right of the Save screen by entering it in this field. Supported with Internet Explorer® ver. 9 and later.

Changing display parameters

You can change display parameters by clicking on the display parameters (**V**, **A**, **W**, **VA**, etc.) in the measured value display area. You can select display parameters by using the computer's **[Shift]** key and **[Ctrl]** key.

For more information, see "Display parameter operation chart" (p.136)

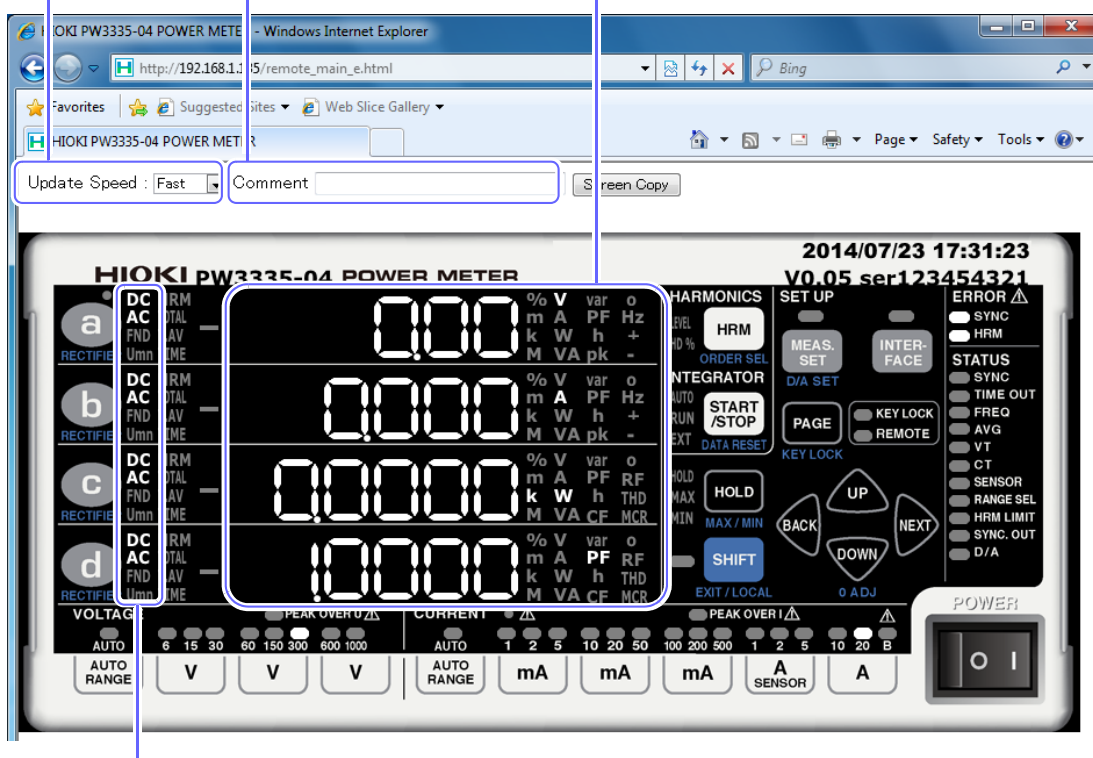

Changing the rectifier

You can change the displayed rectifier by clicking on the rectifier part (**DC**, **AC**, **FND**, **Umn**) of the measured value display area. You can also select ACDC by holding down the computer's **[Shift]** key while you click the rectifier part of the display.

Instrument keys + computer's **[Shift]** key

You can place the instrument in the shift state by holding down the computer's **[Shift]** key while you click on keys on the screen with your mouse.

Example: To select the rectifier

You can set rectifier by clicking the **a** while holding down the computer's **[Shift]** key.



The key lock state cannot be cancelled remotely.

Display parameter operation chart

Voltage, current, and power parameters

Measurement items		Display item to click		Operation
Voltage		V	V	Click
Current		A	A	Click
Active power		W	W	Click
Apparent power		VA	VA	Click
Reactive power		var	var	Click
Power factor		PF	PF	Click
Phase angle		°	o	Click
Frequency	Voltage	VHz	Hz	Click
	Current	AHz	Hz	[Shift] + Click
Waveform peak value	Voltage	V pk	pk	Click
	Current	A pk	pk	[Shift] + Click
Crest factor	Voltage	CF V	CF	Click
	Current	CF A	CF	[Shift] + Click
Maximum current ratio		MCR	MCR	Click
Ripple rate	Voltage	RF V%	RF	Click
	Current	RF A%	RF	[Shift] + Click
Total harmonic distortion	Voltage	THD V%	THD	Click
	Current	THD A%	THD	[Shift] + Click

Total integration display

Measurement items		Display item to click		Operation
Time average current		TOTAL T.AV A	T.AV	Click
Time average active power		TOTAL T.AV W	T.AV	[Shift] + Click
Current integration	Positive	TOTAL Ah+	+	Click
	Negative	TOTAL Ah-	-	Click
	Total	TOTAL Ah	h	Click
Active power integration	Positive	TOTAL Wh+	+	[Shift] + Click
	Negative	TOTAL Wh-	-	[Shift] + Click
	Total	TOTAL Wh	h	[Shift] + Click
Integration time		TOTAL TIME	TIME	Click

Individual current range integration display

Measurement items		Display item to click		Operation
Time average current		T.AV A	T.AV	[Ctrl] + Click
Time average active power		T.AV W	T.AV	[Shift] + [Ctrl] + Click
Current integration	Positive	Ah+	+	[Ctrl] + Click
	Negative	Ah-	-	[Ctrl] + Click
	Total	Ah	h	[Ctrl] + Click
Active power integration	Positive	Wh+	+	[Shift] + [Ctrl] + Click
	Negative	Wh-	-	[Shift] + [Ctrl] + Click
	Total	Wh	h	[Shift] + [Ctrl] + Click
Integration time		TIME	TIME	[Ctrl] + Click

Harmonic level and Harmonic content percentage display

Measurement items		Display item to click		Operation
Harmonic voltage RMS value		HRM V LEVEL	V	Click
Harmonic current RMS value		HRM A LEVEL	A	Click
Harmonic active power		HRM W LEVEL	W	Click
harmonic voltage content percentage		HRM V% HD%	V	Click
harmonic current content percentage		HRM A% HD%	A	Click
harmonic active power content percentage		HRM W% HD%	W	Click

4.3 Canceling the Remote State (Activating the Local State)

During communications, **REMOTE** lamp is lit to indicate the remote control state.

Control keys are disabled, with the exception of **SHIFT**.

If the remote state is activated while the instrument is displaying the Settings screen, it will automatically switch to the normal display (Measurement screen).

SHIFT key (**SHIFT**) is disabled if the GP-IB controller has put the instrument into the local lock out state (**LLO**: Local Lock Out).

In this case, run the **GTL** command of the interface function, or reboot the instrument. Then it returns to the local state.

Canceling the remote state

To switch the instrument from the remote state (with the **REMOTE** lamp lit up) to the local state (with panel operation enabled), press **SHIFT**.

The **REMOTE** lamp will turn off, and use of control keys will be enabled.



Press **SHIFT**.

The **REMOTE** lamp will turn off, enabling use of control keys.



Specifications

Chapter 5

5.1 Environmental and Safety Specifications

Operating environment	Indoors, altitude up to 2000 m (6562 ft.), pollution degree 2
Operating temperature and humidity	0°C to 40°C (32°F to 104°F), 80% RH or less (no condensation)
Storage temperature and humidity	-10°C to 50°C (14°F to 122°F), 80% RH or less (no condensation)
Dielectric strength	4,290 V rms AC (current sensitivity: 1 mA) Between the voltage input terminals and a connection consisting of chassis, interfaces, and output terminals Between the current input terminals and a connection consisting of chassis, interfaces, and output terminals Between the voltage input terminals and current input terminals
Maximum rated voltage to earth	Voltage input terminal, Current input terminal Measurement category III 600 V (anticipated transient overvoltage: 6000 V) Measurement category II 1000 V (anticipated transient overvoltage: 6000 V)
Maximum input voltage	Between the voltage input terminals U and \pm : 1000 V, \pm 1500 V peak For more information about the external current sensors input, see "External Current Sensor Input Specifications (CURRENT SENSOR)" (p.154).
Maximum input current	Between the current input terminals I and \pm : 200 mA to 20 A range 30 A, \pm 100 A peak 1 mA to 100 mA range 20 A, \pm 30 A peak
Standards	Safety EN61010 EMC EN61326 Class A
Effect of radiated radio-frequency electromagnetic field	Current within 0.1 A and external current sensor (using 9661) within 3 A at 10 V/m

5.2 General Specifications

Input specifications

Measurement line type	Single-phase 2-wire(1P2W)		
Input methods	Voltage	Isolated input, resistance voltage division method	
	Current	Isolated input, shunt input method Isolated input from external current sensors (PW3335-03 or PW3335-04 only)	
Input resistance (50 Hz/60 Hz)	Voltage input terminal:	2 MΩ±0.04 MΩ	
	Current input terminal:	1 mA to 100 mA range	500 mΩ + 20 mΩ or less
		200 mA to 20 A range	5 mΩ + 10 mΩ or less (at shipment from factory)
	For more information about the external current sensors input, see "External Current Sensor Input Specifications (CURRENT SENSOR)" (p.154).		
Voltage measurement ranges	AUTO/ 6 V/ 15 V/ 30 V/ 60 V/ 150 V/ 300 V/ 600 V/ 1,000 V		
Current measurement ranges	AUTO/ 1 mA/ 2 mA/ 5 mA/ 10 mA/ 20 mA/ 50 mA/ 100 mA/ 200 mA/ 500 mA/ 1 A/ 2 A/ 5 A/ 10 A/ 20 A		
	For more information about external current sensor input, see "External Current Sensor Input Specifications (CURRENT SENSOR)" (p.154).		

Power ranges: Units; W (active power), VA (apparent power), var (reactive power)

Current/ Voltage	6.0000 V	15.000 V	30.000 V	60.000 V	150.00 V	300.00 V	600.00 V	1.0000 kV
1.0000 mA	6.0000 m	15.000 m	30.000 m	60.000 m	150.00 m	300.00 m	600.00 m	1.0000
2.0000 mA	12.000 m	30.000 m	60.000 m	120.00 m	300.00 m	600.00 m	1.2000	2.0000
5.0000 mA	30.000 m	75.000 m	150.00 m	300.00 m	750.00 m	1.5000	3.0000	5.0000
10.000 mA	60.000 m	150.00 m	300.00 m	600.00 m	1.5000	3.0000	6.0000	10.000
20.000 mA	120.00 m	300.00 m	600.00 m	1.2000	3.0000	6.0000	12.000	20.000
50.000 mA	300.00 m	750.00 m	1.5000	3.0000	7.5000	15.000	30.000	50.000
100.00 mA	600.00 m	1.5000	3.0000	6.0000	15.000	30.000	60.000	100.00
200.00 mA	1.2000	3.0000	6.0000	12.000	30.000	60.000	120.00	200.00
500.00 mA	3.0000	7.5000	15.000	30.000	75.000	150.00	300.00	500.00
1.0000 A	6.0000	15.000	30.000	60.000	150.00	300.00	600.00	1.0000 k
2.0000 A	12.000	30.000	60.000	120.00	300.00	600.00	1.2000 k	2.0000 k
5.0000 A	30.000	75.000	150.00	300.00	750.00	1.5000 k	3.0000 k	5.0000 k
10.000 A	60.000	150.00	300.00	600.00	1.5000 k	3.0000 k	6.0000 k	10.000 k
20.000 A	120.00	300.00	600.00	1.2000 k	3.0000 k	6.0000 k	12.000 k	20.000 k

Default state: voltage range; 300 V, current range; 20 A, power range; 6 kW, voltage/current auto range; OFF

Constraints: Constraints apply when changing ranges as a result of instrument protection mode.

See "Instrument protection mode" (p.162)

Basic Specifications

Rated supply voltage	100 V AC to 240 V AC (Voltage fluctuations of ±10% from the rated supply voltage are taken into account.) Anticipated transient overvoltage: 2500 V
Rated power supply frequency	50 Hz/60 Hz
Maximum rated power	30 VA or less
Dimensions	Approx. 210W × 100H × 245D mm (8.27"W × 3.94"H × 9.65"D) (excluding protrusions)
Mass	Approx. 3 kg (105.8 oz.)
Product warranty period	3 years

Display Specifications

Display	7-segment LED
Number of display parameters	4 (display area a, b, c, and d)
Display resolution	Other than integrated values: 99999 count (5 digits) Integrated values: 999999 count (6 digits)
Display update rate	200 ms \pm 50 ms (approx. 5 updates per sec.) to 20 s (varies with number of averaging iterations setting)

External interface specifications

LAN interface (standard equipment)

Connector	RJ-45 connector \times 1
Electrical specifications	Compliant with IEEE802.3
Transmission method	10Base-T/ 100Base-TX (automatic detection)
Protocol	TCP/ IP
Functions	HTTP server (remote operation, firmware updates) Dedicated ports (command control, data transfer) Remote control by controller (REMOTE lamp will light up.) Cancellation of remote operation with LOCAL key (REMOTE lamp will turn off.)

RS-232C interface

(included with the PW3335, PW3335-02, PW3335-03, and PW3335-04, specify at time of order)

Connector	D-sub 9-pin connector \times 1 (Compatible with 9-pin power supply)
Communication method	Full duplex, Start-stop synchronization Stop bits: 1 (fixed) Data length: 8 (fixed) Parity: None Remote control by controller (REMOTE lamp will light up.) Cancellation of remote operation with LOCAL key (REMOTE lamp will turn off.) Hardware handshake function
Communication speed	9600bps/ 38400bps
Power supply	OFF/ON (voltage +5 V, maximum 200 mA)
Functionality	Command control, data transfers, and LR8410 Link support

GP-IB interface (included with the PW3335-01 and PW3335-04, specify at time of order)

Method	Compliant with IEEE488.1 1987, in reference to IEEE488.2 1987 Interface functions: SH1, AH1, T6, L4, SR1, RL1, PP0, DC1, DT1, C0 Remote control by controller (REMOTE lamp will light up.) Cancellation of remote operation with LOCAL key (REMOTE lamp will turn off.)
Address	00 to 30

Accessory and Option Specifications

Accessories	See: "Instrument and accessories" (p.2)
Options	See: "Options (sold separately)" (p.2)

5.3 Measurement specifications

Accuracy

We define measurement tolerances in terms of f.s. (full scale), rdg. (reading) and dgt. (digit) values, with the following meanings:

f.s. (range)	This is usually the name of the currently selected range.
rdg. (reading or displayed value)	The value currently being measured and indicated on the measuring instrument.
dgt. (resolution)	The smallest displayable unit on a digital measuring instrument, i.e., the input value that causes the digital display to show a "1" as the least-significant digit.

Basic Measurement Specifications

Measurement method	Simultaneous voltage and current digital sampling, zero-cross simultaneous calculation		
Sampling frequency	Approx. 700 kHz		
A/D converter resolution	16-bit		
Frequency bands	DC, 0.1 Hz to 100 kHz (Reference value of $0.1 \text{ Hz} \leq f < 10 \text{ Hz}$)		
Synchronization sources (SYNC)	<p>U, I, DC (fixed to 200 ms) (default state: U)</p> <p>When an AC measured value of a signal input to the source is less than 1%f.s. of the set range, operation and accuracy are not defined.</p> <p>When synchronization cannot be detected, the SYNC lamp (ERROR) will light up, and operation and accuracy are not defined.</p> <p>When the synchronization source is DC, accuracy is not defined for input with a cycle that is not divisible by 200 ms.</p> <p>Synchronization timeout setting: 0.1 sec. / 1 sec. / 10 sec. (linked to measurement lower limit frequency setting, default state: 0.1 sec.)</p>		
Measurement items	<p>Voltage, current, active power, apparent power, reactive power, power factor, phase angle, frequency, current integration, active power integration, integration time, voltage waveform peak value, current waveform peak value, voltage crest factor, current crest factor, maximum current ratio, time average current, time average active power, voltage ripple rate, current ripple rate</p> <p>Harmonic parameters</p> <p>Harmonic voltage RMS value, harmonic current RMS value, harmonic active power, total harmonic voltage distortion, total harmonic current distortion, fundamental wave voltage, fundamental wave current, fundamental wave active power, fundamental wave apparent power, fundamental wave reactive power, fundamental wave power factor (displacement power factor), fundamental wave voltage current phase difference, harmonic voltage content percentage, harmonic current content percentage, harmonic active power content percentage</p> <p>(The following parameters can be downloaded as data with communications but not displayed): Harmonic voltage phase angle, harmonic current phase angle, harmonic voltage current phase difference</p> <p>(Default state: display area a; voltage, display area b; current, display area c; active power, display area d; power factor)</p>		
Rectifiers	AC+DC	AC+DC measurement	Display of true RMS values for both voltage and current
	AC+DC Umn	AC+DC measurement	Display of average value rectified RMS converted values for voltage and true RMS values for current
	DC	DC measurement	Display of simple averages for both voltage and current
			Display of values calculated by (voltage DC value) × (current DC value) for active power
	AC	AC measurement	Display of values calculated by
			$\sqrt{(\text{AC+DC value})^2 - (\text{DC value})^2}$ for both voltage and current
			Display of values calculated by (AC+DC value) - (DC value) for active power
	FND (Default state:	Extraction and display of the fundamental wave component from harmonic measurement AC+DC for all display areas)	
Zero-cross Filter	<p>100 Hz/ 500 Hz/ 5 kHz/ 100 kHz (linked to frequency measurement range, default state: 500 Hz)</p> <p>100 Hz: 0.1 Hz to 100 Hz 500 Hz: 0.1 Hz to 500 Hz 5 kHz: 0.1 Hz to 5 kHz 100 kHz: 0.1 Hz to 100 kHz</p> <p>The zero-cross filter lower limit setting is linked to the synchronization timeout setting. 10 Hz/ 1 Hz/ 0.1 Hz</p>		

Measurement accuracy

For more information about the measurement accuracy for input from external current sensors, see "Measurement accuracy" (p.156).

Voltage

Frequency (f)	Input < 50%f.s.	50%f.s. ≤ Input < 100%f.s.	100%f.s. ≤ Input
DC	±0.1% rdg.±0.1%f.s.	±0.1% rdg.±0.1%f.s.	±0.2% rdg.
0.1 Hz ≤ f < 16 Hz	±0.1% rdg.±0.2%f.s.	±0.3% rdg.	±0.3% rdg.
16 Hz ≤ f < 45 Hz	±0.1% rdg.±0.1%f.s.	±0.2% rdg.	±0.2% rdg.
45 Hz ≤ f ≤ 66 Hz	±0.1% rdg.±0.05%f.s.	±0.15% rdg.	±0.15% rdg.
66 Hz < f ≤ 500 Hz	±0.1% rdg.±0.1%f.s.	±0.2% rdg.	±0.2% rdg.
500 Hz < f ≤ 10 kHz	±0.1% rdg.±0.2%f.s.	±0.3% rdg.	±0.3% rdg.
10 kHz < f ≤ 50 kHz	±0.5% rdg.±0.3%f.s.	±0.8% rdg.	±0.8% rdg.
50 kHz < f ≤ 100 kHz	±2.1% rdg.±0.3%f.s.	±2.4% rdg.	±2.4% rdg.

Current

Frequency (f)	Input < 50%f.s.	50%f.s. ≤ Input < 100%f.s.	100%f.s. ≤ Input
DC	±0.1% rdg.±0.1%f.s.	±0.1% rdg.±0.1%f.s.	±0.2% rdg.
0.1 Hz ≤ f < 16 Hz	±0.1% rdg.±0.2%f.s.	±0.3% rdg.	±0.3% rdg.
16 Hz ≤ f < 45 Hz	±0.1% rdg.±0.1%f.s.	±0.2% rdg.	±0.2% rdg.
45 Hz ≤ f ≤ 66 Hz	±0.1% rdg.±0.05%f.s.	±0.15% rdg.	±0.15% rdg.
66 Hz < f ≤ 500 Hz	±0.1% rdg.±0.1%f.s.	±0.2% rdg.	±0.2% rdg.
500 Hz < f ≤ 1 kHz	±0.1% rdg.±0.2%f.s.	±0.3% rdg.	±0.3% rdg.
1 kHz < f ≤ 10 kHz	±(0.03+0.07×F)% rdg.±0.2%f.s.	±(0.23+0.07×F)% rdg.	±(0.23+0.07×F)% rdg.
10 kHz < f ≤ 100 kHz	±(0.3+0.04×F)% rdg.±0.3%f.s.	±(0.6+0.04×F)% rdg.	±(0.6+0.04×F)% rdg.

Active power

Frequency (f)	Input < 50%f.s.	50%f.s. ≤ Input < 100%f.s.	100%f.s. ≤ Input
DC	±0.1% rdg.±0.1%f.s.	±0.1% rdg.±0.1%f.s.	±0.2% rdg.
0.1 Hz ≤ f < 16 Hz	±0.1% rdg.±0.2%f.s.	±0.3% rdg.	±0.3% rdg.
16 Hz ≤ f < 45 Hz	±0.1% rdg.±0.1%f.s.	±0.2% rdg.	±0.2% rdg.
45 Hz ≤ f ≤ 66 Hz	±0.1% rdg.±0.05%f.s.	±0.15% rdg.	±0.15% rdg.
66 Hz < f ≤ 500 Hz	±0.1% rdg.±0.1%f.s.	±0.2% rdg.	±0.2% rdg.
500 Hz < f ≤ 1 kHz	±0.1% rdg.±0.2%f.s.	±0.3% rdg.	±0.3% rdg.
1 kHz < f ≤ 10 kHz	±(0.03+0.07×F)% rdg.±0.2%f.s.	±(0.23+0.07×F)% rdg.	±(0.23+0.07×F)% rdg.
10 kHz < f ≤ 50 kHz	±(0.07×F)% rdg.±0.3%f.s.	±(0.3+0.07×F)% rdg.	±(0.3+0.07×F)% rdg.
50 kHz < f ≤ 100 kHz	±(0.6+0.07×F)% rdg.±0.3%f.s.	±(0.9+0.07×F)% rdg.	±(0.9+0.07×F)% rdg.

- Values for f.s. depend on measurement ranges.
- "F" in the tables refers to the frequency in kHz.
- When using the 1 mA/ 2 mA range
Add ±1 µA to 0.1 Hz to 100 kHz measurement accuracy for current.
Add (±1 µA) × (voltage read value) to 0.1 Hz to 100 kHz measurement accuracy for active power.
- When using the 200 mA/ 500 mA/ 1 A/ 2 A/ 5 A/ 10 A/ 20 A range
Add ±1 mA to DC measurement accuracy for current.
Add (±1 mA) × (voltage read value) to DC measurement accuracy for active power.
- When using the 1 mA/ 2 mA/ 5 mA/ 10 mA/ 20 mA/ 50 mA/ 100 mA range
Add ±10 µA to DC measurement accuracy for current.
Add (±10 µA) × (voltage read value) to DC measurement accuracy for active power.
- When using the 200 mA/ 500 mA/ 1 A/ 2 A/ 5 A/ 10 A/ 20 A range
Add ±(0.02×F)% rdg. to the measurement accuracy for current and active power for which (10 kHz < f ≤ 100 kHz).
- The following input are considered reference values:
Values for voltage, current, and active power for which 0.1 Hz ≤ f < 10 Hz.
Values for voltage, current, and active power in excess of 220 V or 20 A for which 10 Hz ≤ f < 16 Hz.
Values for current and active power in excess of 20 A for which 500 Hz < f ≤ 50 kHz.
Values for current and active power in excess of 10 A for which 50 kHz < f ≤ 100 kHz.
Values for voltage and active power in excess of 750 V for which 30 kHz < f ≤ 100 kHz.

5.3 Measurement specifications

Effective measuring range	Voltage: 1% to 150% of the range (1,000 V range, up to 1,000 V) Current: 1% to 150% of the range Active power: 0% to 225% of the range (when using 1,000 V range, up to 150%) However, valid when the voltage and current fall within the effective measurement range. Other parameters: Valid within the voltage, current, and active power effective measurement range.
Maximum effective peak voltage	±600% of each voltage range However, for 300 V, 600 V, and 1,000 V ranges, ±1,500 V peak
Maximum effective peak current	±600% of each current range However, for 20 A range, ±60 A peak
Guaranteed accuracy period	1 year
Conditions of guaranteed accuracy	Temperature and humidity range: 23°C±5°C (73°F±9°F), 80% RH or less Warm-up time: 30 minutes Input: Sine wave input, power factor of 1, voltage to earth of 0 V, after zero-adjustment; within range in which the fundamental wave satisfies synchronization source conditions
Temperature coefficient	±0.03%f.s. per °C or less. However, for 1 mA range, ±0.06%f.s. per °C or less.
Effect of power factor	±0.1%f.s. or less (45 to 66 Hz, at power factor = 0) Internal circuitry voltage/current phase difference: ±0.0573°
Effect of common mode voltage	±0.01%f.s. or less (600 V, 50 Hz/60 Hz, applied between input terminals and enclosure)
Magnetic field interference	400 A/m, DC and 50 Hz/60 Hz magnetic field Voltage ±1.5%f.s. or less Current ±1.5%f.s. or below value, whichever is greater, or less 200 mA/ 500 mA/ 1 A/ 2 A/ 5 A/ 10 A/ 20 A range: ±20 mA 1 mA/ 2 mA/ 5 mA/ 10 mA/ 20 mA/ 50 mA/ 100 mA range: ±200 µA Active power ±3.0%f.s. or below value, whichever is greater, or less 200 mA/ 500 mA/ 1 A/ 2 A/ 5 A/ 10 A/ 20 A range: (Voltage influence quantity)×(±20 mA) 1 mA/ 2 mA/ 5 mA/ 10 mA/ 20 mA/ 50 mA/ 100 mA range: (Voltage influence quantity)×(±200 µA)
Effect of self-heating	With input of at least 15 A to current input terminals Current AC input signal ±(0.025+0.005×(I-15))%rdg. or less DC input signal 200 mA/ 500 mA/ 1 A/ 2 A/ 5 A/ 10 A/ 20 A range ±((0.025+0.005×(I-15))% rdg.+(0.5+0.1×(I-15))mA) or less 1 mA/ 2 mA/ 5 mA/ 10 mA/ 20 mA/ 50 mA/ 100 mA range ±((0.025+0.005×(I-15))% rdg.+(5+1×(I-15))µA) or less I: Current read value (A) Active power (above current influence quantity) × (voltage read value) or less The effects of self-heating will continue to manifest themselves until the input resistance temperature falls, even if the current value is low.

Voltage Measurement Specifications (U: Displayed as V on panel display)

Measurement types	Rectifiers: AC+DC, DC, AC, FND, AC+DC Umn
Effective measuring range	±1% to ±150% of the range. However, up to ±1,500 V peak value and 1,000 V RMS value
Display range	Up to ±152% of the range. However, zero-suppression when less than ±0.5%
Polarity	Displayed when using DC rectifier
Over-range display	Displays [o.r.] (over-range) when input exceeds ±152% of the range or ±1,060.5 V.
Peak exceeded warning	The PEAK OVER U lamp will light up for which the input voltage peak value exceeds ±1,500 V or ±600% of the range.

Current Measurement Specifications (I: Displayed as A on panel display)

Measurement types	Rectifiers: AC+DC, DC, AC, FND, AC+DC Umn
Effective measuring range	$\pm 1\%$ to $\pm 150\%$ of the range
Display range	Up to $\pm 152\%$ of the range. However, zero-suppression when less than $\pm 0.5\%$ or less than $\pm 9 \mu\text{A}$.
Polarity	Displayed when using DC rectifier
Over-range display	Displays [o.r] when input exceeds $\pm 152\%$ of the range.
Peak exceeded warning	The PEAK OVER I lamp will light up for which the input current peak value exceeds $\pm 60 \text{ A}$ or $\pm 600\%$ of the range.

Active Power Measurement Specifications (P: Displayed as W on panel display)

Measurement types	Rectifiers: AC+DC, DC, AC, FND, AC+DC Umn
Effective measuring range	$\pm 0\%$ to $\pm 225\%$ of the range. However, valid when the voltage and current fall within the effective measurement range.
Display range	$\pm 0\%$ to $\pm 231.04\%$ of the range (no zero-suppression)
Polarity	Positive: Power consumption (no polarity display); negative: generation or regenerated power
Over-range display	Displays [o.r] when input exceeds $\pm 231.04\%$ of the range. However, for 1000 V range, displays [o.r] when input exceeds $\pm 161.196\%$.

Apparent Power Measurement Specifications (S: Displayed as VA on panel display)

Measurement types	Rectifiers: AC+DC, AC, FND, AC+DC Umn
Effective measuring range	As per voltage and current effective measurement ranges.
Display range	0% to 231.04% of the range (no zero-suppression) When using the AC+DC or AC rectifier, displays S as P when $ P > S$.
Over-range display	Displays [o.r] when displaying [o.r] for either voltage or current.
Invalid data display	Displays [- - - -] when using the DC rectifier.

Reactive Power Measurement Specifications (Q: Displayed as var on panel display)

Measurement types	Rectifiers: AC+DC, AC, FND, AC+DC Umn
Effective measuring range	As per voltage, current, and active power effective measurement ranges.
Display range	$\pm 0\%$ to $\pm 231.04\%$ of the range (no zero-suppression)
Polarity	Polarity is assigned according to the lead/lag relationship of the voltage waveform rising edge and the current waveform rising edge. +: When current lags voltage (no polarity display) -: When current leads voltage
Polarity effective range	With the AC+DC, AC, or AC+DC Umn rectifier: Sine-wave input equivalent to at least 20% of the measurement range, frequency of 10 Hz to 20 kHz, phase difference of $\pm(1^\circ \text{ to } 179^\circ)$
Over-range display	Displays [o.r] when displaying [o.r] for the voltage, current, or active power.
Invalid data display	Displays [- - - -] when using the DC rectifier.

Power Factor Measurement Specifications (λ : Displayed as PF on panel display)

Measurement types	Rectifiers: AC+DC, AC, FND, AC+DC Umn
Effective measuring range	As per voltage, current, and active power effective measurement ranges
Display range	± 0.0000 to ± 1.0000
Polarity	Polarity is assigned according to the lead/lag relationship of the voltage waveform rising edge and the current waveform rising edge. +: When current lags voltage (no polarity display) -: When current leads voltage
Polarity effective range	With the AC+DC, AC, or AC+DC Umn rectifier: Sine-wave input equivalent to at least 20% of the measurement range, frequency of 10 Hz to 20 kHz, phase difference of $\pm(1^\circ$ to $179^\circ)$
Over-range display	Displays [o.r] when [o.r] is displayed for the voltage or current. Displays [o.r] when the apparent power is 0.
Invalid data display	Displays [- - - -] when using the DC rectifier.

Phase Angle Measurement Specifications (φ : Displayed as $^\circ$ on panel display)

Measurement types	Rectifiers: AC, FND
Effective measuring range	As per voltage, current, and active power effective measurement ranges
Display range	+180.00 to -180.00
Polarity	Polarity is assigned according to the lead/lag relationship of the voltage waveform rising edge and the current waveform rising edge. +: When current lags voltage (no polarity display) -: When current leads voltage
Polarity effective range	With the AC rectifier: Sine-wave input equivalent to at least 20% of the measurement range, frequency of 10 Hz to 20 kHz, phase difference of $\pm(1^\circ$ to $179^\circ)$
Over-range display	Displays [o.r] when displaying [o.r] for the power factor.
Invalid data display	Displays [- - - -] when using the AC+DC, AC+DC Umn, or DC rectifier.

**Frequency Measurement Specifications
(f: Displayed as V Hz or A Hz on panel display)**

Number of measurement channels	2
Measurement method	Calculated from input waveform period (reciprocal method)
Measurement ranges	100 Hz/ 500 Hz/ 5 kHz/ 100 kHz (linked to zero-cross filter)
Measurement accuracy	$\pm 0.1\%$ rdg. ± 1 dgt. However, for 1 mA range, $\pm 0.2\%$ rdg. ± 1 dgt. (for the minimum frequency range setting that satisfies the measurement frequency)
Effective measuring range	0.1 Hz to 100 kHz For sine wave input that is at least 20% of the measurement source's measurement range Measurement lower limit frequency setting: 0.1 sec. / 1 sec. / 10 sec. (linked to synchronization timeout setting)
Display format	0.1000 Hz to 9.9999 Hz, 9.900 Hz to 99.999 Hz, 99.00 Hz to 999.99 Hz, 0.9900 kHz to 9.9999 kHz, 9.900 kHz to 99.999 kHz, 99.00 kHz to 100.00 kHz
Over-range display	Displays [o.r] when input falls outside the measurement range.
Default state	Frequency range: 500 Hz

Integration Measurement Specifications

Integration operation modes	<p>Switchable between fixed-range integration and auto-range integration.</p> <p>Fixed-range integration Integration can be performed for all voltage and current ranges. The voltage and current ranges are fixed once integration starts. Other settings continue to be in effect. The current range keys are disabled.</p> <p>Auto-range integration Integration can be performed for all voltage ranges. The current is set to auto-range operation using ranges from 200 mA to 20 A. (The current AUTO lamp will light up.) If the operating mode is set to auto-range integration, the AUTO lamp to the left of the START/STOP key will light up. When integration starts, the voltage range is fixed, and the timeout value is set to 0.1 s. The integrated value for each range can be displayed by switching the current range (200 mA to 20 A) while integration is stopped.</p>																					
Measurement items and display	<p>Simultaneous integration of the following 6 parameters: Positive current integrated value (displayed as Ah+ on panel display) Negative current integrated value (displayed as Ah- on panel display) Sum of current integrated values (displayed as Ah on panel display) Positive active power integrated value (displayed as Wh+ on panel display) Negative active power integrated value (displayed as Wh- on panel display) Sum of active power integrated values (displayed as Wh on panel display) When the TOTAL lamp is lit up on the integration display In auto-range integration mode, the sum of integrated values for all ranges is displayed. In fixed-range integration mode, the integrated value for the range being shown is displayed. When the TOTAL lamp is turned off on the integration display The integrated value for the range being shown is displayed.</p>																					
Measurement types	<p>Rectifiers: AC+DC, AC+DC Umn Current: Displays the result of integrating current RMS value data (display values) once every display update interval as an integrated value. Active power: Displays the result of integrating active power values by polarity calculated once every cycle for the selected synchronization source as integrated values.</p> <p>Rectifier: DC Displays the result of integrating instantaneous data obtained by sampling both current and active power by polarity as integrated values (these values are not integrated values for the DC component when active power contains both DC and AC components)</p> <p style="text-align: right;">●: Displayed -: Displays [- - - -]</p> <table border="1"> <thead> <tr> <th>Rectifier</th> <th>Ah+</th> <th>Ah-</th> <th>Ah</th> <th>Wh+</th> <th>Wh-</th> <th>Wh</th> </tr> </thead> <tbody> <tr> <td>AC+DC, AC+DC Umn</td> <td>-</td> <td>-</td> <td>●*</td> <td>●</td> <td>●</td> <td>●</td> </tr> <tr> <td>DC</td> <td>●</td> <td>●</td> <td>●</td> <td>●</td> <td>●</td> <td>●</td> </tr> </tbody> </table> <p>* In auto-range integration mode, [- - - -] will be displayed.</p>	Rectifier	Ah+	Ah-	Ah	Wh+	Wh-	Wh	AC+DC, AC+DC Umn	-	-	●*	●	●	●	DC	●	●	●	●	●	●
Rectifier	Ah+	Ah-	Ah	Wh+	Wh-	Wh																
AC+DC, AC+DC Umn	-	-	●*	●	●	●																
DC	●	●	●	●	●	●																
Integration time	1 min. to 10,000 hr., settable in 1 min. blocks Default value: 10,000 hr. (0000.00 display)																					
Integration time accuracy	±0.01% rdg. ±1 dgt.																					
Integration measurement accuracy	(Current or active power measurement accuracy) + (±0.01% rdg. ±1 dgt.)																					
Effective measuring range	Until PEAK OVER U lamp or PEAK OVER I lamp lights up. However, the range is defined only if the input voltage and current are 1% or more of the corresponding ranges.																					
Display resolution	999999 (6 digits + decimal point)																					
Peak exceeded warning	If PEAK OVER U lamp or PEAK OVER I lamp lights up during integration operation, the unit (Ah , Ah+ , Ah- , Wh , Wh+ , Wh-) will flash.																					
Invalid data display	Displays [- - - -] when using the AC or FND rectifier.																					

Integration status display	During integration operation	RUN lamp lights up (during external control operation, EXT lamp lights up)																																
	When stopped	RUN lamp flashing (during external control operation, EXT lamp lights up)																																
	Integrated value reset	RUN lamp off (during external control operation, EXT lamp off)																																
Functions	Stopping integration based on integration time setting (timer) Stopping/starting integration and resetting integrated values based on external control Displaying the integration elapsed time (displayed as TIME on panel display) Additional integration by repeatedly starting/stopping integration Backing up integrated values and the integration elapsed time during power outages Stopping integration when power returns																																	
Default state	Integration time: 10,000 hr., integration operation with the integrated value in the reset state Auto-range integration: OFF (Fixed-range integration)																																	
External control	Input signal level: 0 to 5 V (high-speed CMOS level) or shorted [Lo]/open [Hi]																																	
	<table border="1"> <thead> <tr> <th>Functions</th> <th>External control signal</th> <th>External control terminal</th> </tr> </thead> <tbody> <tr> <td>Starts integration</td> <td>Hi → Lo</td> <td rowspan="2">START/STOP</td> </tr> <tr> <td>Stops integration</td> <td>Lo → Hi</td> </tr> <tr> <td>Resets integrated values</td> <td>Lo interval of at least 200 ms</td> <td>RESET</td> </tr> </tbody> </table>		Functions	External control signal	External control terminal	Starts integration	Hi → Lo	START/STOP	Stops integration	Lo → Hi	Resets integrated values	Lo interval of at least 200 ms	RESET																					
Functions	External control signal	External control terminal																																
Starts integration	Hi → Lo	START/STOP																																
Stops integration	Lo → Hi																																	
Resets integrated values	Lo interval of at least 200 ms	RESET																																
Constraints	During integration operation and while integration is stopped, the following operational constraints apply until integrated values are reset: ●: Setting and changes allowed —: Setting and changes not allowed																																	
	<table border="1"> <thead> <tr> <th>Item</th> <th>During integration operation or while integration is stopped</th> </tr> </thead> <tbody> <tr> <td>Measurement range</td> <td>— However, during auto-range integration, auto-range operation is used to determine the current range.</td> </tr> <tr> <td>Current input method switching</td> <td>—</td> </tr> <tr> <td>Frequency measurement range (Zero-Cross Filter)</td> <td>—</td> </tr> <tr> <td>Timeout</td> <td>—</td> </tr> <tr> <td>Integration time</td> <td>—</td> </tr> <tr> <td>Synchronization source</td> <td>—</td> </tr> <tr> <td>Zero Adjustment</td> <td>— (Can be adjusted while integration is stopped.)</td> </tr> <tr> <td>D/A output parameters</td> <td>●</td> </tr> <tr> <td>Number of averaging iterations</td> <td>—</td> </tr> <tr> <td>VT ratio</td> <td>—</td> </tr> <tr> <td>CT ratio</td> <td>—</td> </tr> <tr> <td>RS-232C transfer speed</td> <td>●</td> </tr> <tr> <td>GP-IB address</td> <td>●</td> </tr> <tr> <td>LAN</td> <td>●</td> </tr> <tr> <td>Harmonic analysis order upper limit value</td> <td>—</td> </tr> </tbody> </table>		Item	During integration operation or while integration is stopped	Measurement range	— However, during auto-range integration, auto-range operation is used to determine the current range.	Current input method switching	—	Frequency measurement range (Zero-Cross Filter)	—	Timeout	—	Integration time	—	Synchronization source	—	Zero Adjustment	— (Can be adjusted while integration is stopped.)	D/A output parameters	●	Number of averaging iterations	—	VT ratio	—	CT ratio	—	RS-232C transfer speed	●	GP-IB address	●	LAN	●	Harmonic analysis order upper limit value	—
Item	During integration operation or while integration is stopped																																	
Measurement range	— However, during auto-range integration, auto-range operation is used to determine the current range.																																	
Current input method switching	—																																	
Frequency measurement range (Zero-Cross Filter)	—																																	
Timeout	—																																	
Integration time	—																																	
Synchronization source	—																																	
Zero Adjustment	— (Can be adjusted while integration is stopped.)																																	
D/A output parameters	●																																	
Number of averaging iterations	—																																	
VT ratio	—																																	
CT ratio	—																																	
RS-232C transfer speed	●																																	
GP-IB address	●																																	
LAN	●																																	
Harmonic analysis order upper limit value	—																																	
	If the instrument protection mode is activated during integration in a fixed range, integration will be forcibly stopped (causing the RUN lamp to flash, and it will not be possible to resume integration operation).																																	

Voltage Waveform Peak Value Measurement Specifications (Upk: Displayed as V pk on panel display)

Measurement method	Measures the voltage waveform's peak value (for both positive and negative polarity) based on sampled instantaneous voltage values.																									
Range configuration	<table border="1"> <thead> <tr> <th>Voltage range</th> <th>6 V</th> <th>15 V</th> <th>30 V</th> <th>60 V</th> <th>150 V</th> <th>300 V</th> <th>600 V</th> <th>1000 V</th> </tr> </thead> <tbody> <tr> <td>Voltage peak range</td> <td>36.000 V</td> <td>90.000 V</td> <td>180.00 V</td> <td>360.00 V</td> <td>900.00 V</td> <td>1.8000 kV</td> <td>3.6000 kV</td> <td>6.0000 kV</td> </tr> </tbody> </table>								Voltage range	6 V	15 V	30 V	60 V	150 V	300 V	600 V	1000 V	Voltage peak range	36.000 V	90.000 V	180.00 V	360.00 V	900.00 V	1.8000 kV	3.6000 kV	6.0000 kV
Voltage range	6 V	15 V	30 V	60 V	150 V	300 V	600 V	1000 V																		
Voltage peak range	36.000 V	90.000 V	180.00 V	360.00 V	900.00 V	1.8000 kV	3.6000 kV	6.0000 kV																		
Measurement accuracy	±2.0%f.s. at DC and when 10 Hz ≤ f ≤ 1 kHz (f.s.: voltage peak range). Provided as reference value when 0.1 Hz ≤ f < 10 Hz and when 1 kHz < f.																									
Effective measuring range	±5% to ±100% of voltage peak range, however, up to ±1,500 V																									
Display range	Up to ±102% of voltage peak range, however, the value 0 will be displayed if the voltage RMS value triggers the instrument's zero suppression function.																									
Over-range display	Displays [o.r] when input exceeds ±102% of the voltage peak range.																									
Default state	Voltage peak range: 1.8 kV																									

Current Waveform Peak Value Measurement Specifications (Ipk: Displayed as A pk on panel display)

Measurement method	Measures the current waveform's peak value (for both positive and negative polarity) based on sampled instantaneous current values.						
Range configuration							
Current range	1 mA	2 mA	5 mA	10 mA	20 mA	50 mA	100 mA
Current peak range	6.0000 mA	12.000 mA	30.000 mA	60.000 mA	120.00 mA	300.00 mA	600.00 mA
Current range	200 mA	500 mA	1 A	2 A	5 A	10 A	20 A
Current peak range	1.2000 A	3.0000 A	6.0000 A	12.000 A	30.000 A	60.000 A	120.00 A
Measurement accuracy	±2.0%f.s. at DC and when $10 \text{ Hz} \leq f \leq 1 \text{ kHz}$ (f.s.: current peak range). Provided as reference value when $0.1 \text{ Hz} \leq f < 10 \text{ Hz}$ and when $1 \text{ kHz} < f$. The above measurement accuracy is multiplied by 2 for the 1 mA range.						
Effective measuring range	±5% to ±100% of current peak range, however, up to ±60 A						
Display range	Up to ±102% of current peak range, however, the value 0 will be displayed if the current RMS value triggers the instrument's zero suppression function.						
Over-range display	Displays [o.r] when input exceeds ±102% of the current peak range.						
Default state	Current peak range: 120 A						

Voltage Crest Factor Measurement Specifications (Ucf: Displayed as CF V on panel display)

Measurement method	Calculates the ratio of the voltage waveform peak value to the voltage RMS value.
Effective measuring range	As per voltage and voltage waveform peak value effective measurement ranges.
Display range	1.0000 to 612.00 (no polarity)
Over-range display	Displays [o.r] when [o.r] is displayed for the voltage waveform peak value. Displays [o.r] when [o.r] is displayed for the voltage or the voltage is 0.

Current Crest Factor Measurement Specifications (Icf: Displayed as CF A on panel display)

Measurement method	Calculates the ratio of the current waveform peak value to the current RMS value.
Effective measuring range	As per current and current waveform peak value effective measurement ranges.
Display range	1.0000 to 612.00 (no polarity)
Over-range display	Displays [o.r] when [o.r] is displayed for the current waveform peak value. Displays [o.r] when [o.r] is displayed for the current or the current is 0.

Time Average Current Measurement Specifications (T.AV I: Displayed as T.AV A on panel display)

Measurement method	Calculates the average by dividing the current integrated value by the integration time.
Measurement accuracy	(Current measurement accuracy) + (±0.01% rdg. ±1 dgt.)
Effective measuring range	As per the current integration effective measurement range.
Display range	±0% to ±612% of the range (no [o.r] display)
Polarity	Has polarity when using the DC rectifier.
Peak exceeded warning	If the integrated value includes data from when the PEAK OVER I lamp lit up, the unit A will flash.
Invalid data display	Displays [- - - -] when using the AC or FND rectifier. If the auto-range integration mode rectifier is AC+DC or AC+DC Umn, [- - - -] will be displayed.
Display types	When the TOTAL lamp is lit up In auto-range integration mode, the time-average value for the overall range is displayed. When the TOTAL lamp is turned off, or when using fixed-range integration mode The time-average value for the range being shown is displayed.

Time Average Active Power Measurement Specifications (T.AV P: Displayed as T.AV W on panel display)

Measurement method	Calculates the average by dividing the active power integrated value by the integration time.
Measurement accuracy	(Active power measurement accuracy) + ($\pm 0.01\%$ rdg. ± 1 dgt.)
Effective measuring range	As per the active power integration effective measurement range.
Display range	$\pm 0\%$ to $\pm 3,745.4\%$ of the range (no [o.r] display)
Polarity	Yes
Peak exceeded warning	If the integrated value includes data from when the PEAK OVER U or PEAK OVER I lamp lit up, the unit W will flash.
Invalid data display	Displays [- - - -] when using the AC or FND rectifier.
Display types	When the TOTAL lamp is lit up In auto-range integration mode, the time-average value for the overall range is displayed. When the TOTAL lamp is turned off, or when using fixed-range integration mode The time-average value for the range being shown is displayed.

Voltage Ripple Rate Measurement Specifications (Urf: Displayed as RF V % on panel display)

Measurement method	Calculates the AC component (peak to peak [peak width]) as a proportion of the voltage DC component.
Effective measuring range	As per voltage and voltage waveform peak value effective measurement ranges.
Display range	0.00 to 500.00
Polarity	None
Over-range display	Displays [o.r] when [o.r] is displayed for the voltage waveform peak value. Displays [o.r] when [o.r] is displayed for the voltage or the voltage is 0.

Current Ripple Rate Measurement Specifications (Irf: Displayed as RF A % on panel display)

Measurement method	Calculates the AC component (peak to peak [peak width]) as a proportion of the current DC component.
Effective measuring range	As per current and current waveform peak value effective measurement ranges.
Display range	0.00 to 500.00
Polarity	None
Over-range display	Displays [o.r] when [o.r] is displayed for the current waveform peak value. Displays [o.r] when [o.r] is displayed for the current or the current is 0.

Maximum Current Ratio Measurement Specifications (MCR)

Measurement method	Calculates the ratio of the current crest factor to the power factor.
Effective measuring range	As per power factor (voltage, current, active power) and current crest factor (current, current waveform peak value) effective measurement ranges.
Display range	1.0000 to 6.1200 M
Polarity	None
Over-range display	Displays [o.r] (MCR > 10) when [0.0000] is displayed for the power factor. Displays [o.r] (MCR > 10) when [o.r] is displayed for the current crest factor.

Harmonic Measurement Specifications

Measurement method	Zero-cross simultaneous calculation method Uniform thinning between zero-cross events after processing with a digital antialiasing filter Interpolation calculations (Lagrange interpolation) When the synchronization frequency falls within the 45 Hz to 66 Hz range IEC 61000-4-7:2002 compliant Gaps and overlaps may occur if the measurement frequency is not 50 Hz or 60 Hz. When the synchronization frequency falls outside the 45 Hz to 66 Hz range No gaps or overlap will occur.																			
Synchronization source	Conforms to synchronization source (SYNC) for the basic measurement specifications.																			
Measurement items	Harmonic voltage RMS value, harmonic voltage content percentage, harmonic voltage phase angle, harmonic current RMS value, harmonic current content percentage, harmonic current phase angle, harmonic active power, harmonic active power content percentage, harmonic voltage current phase difference, total harmonic voltage distortion, total harmonic current distortion, fundamental wave voltage, fundamental wave current, fundamental wave active power, fundamental wave apparent power, fundamental wave reactive power, fundamental wave power factor, fundamental wave voltage current phase difference (The following parameters can be downloaded as data with communications but not displayed:) Harmonic voltage phase angle, harmonic current phase angle, harmonic voltage current phase difference																			
FFT processing word length, number of FFT points	32 bits, 4,096 points																			
Window function	Rectangular																			
Analysis window width	<table border="1"> <thead> <tr> <th>Frequency (f)</th> <th>Window width</th> </tr> </thead> <tbody> <tr> <td>45 Hz \leq f < 56 Hz</td> <td>178.57 ms to 222.22 ms (10 cycles)</td> </tr> <tr> <td>56 Hz \leq f < 66 Hz</td> <td>181.82 ms to 214.29 ms (12 cycles)</td> </tr> <tr> <td>Frequencies other than the above</td> <td>185.92 ms to 214.08 ms</td> </tr> </tbody> </table>		Frequency (f)	Window width	45 Hz \leq f < 56 Hz	178.57 ms to 222.22 ms (10 cycles)	56 Hz \leq f < 66 Hz	181.82 ms to 214.29 ms (12 cycles)	Frequencies other than the above	185.92 ms to 214.08 ms										
Frequency (f)	Window width																			
45 Hz \leq f < 56 Hz	178.57 ms to 222.22 ms (10 cycles)																			
56 Hz \leq f < 66 Hz	181.82 ms to 214.29 ms (12 cycles)																			
Frequencies other than the above	185.92 ms to 214.08 ms																			
Data update rate	Depends on window width.																			
Maximum analysis order	Synchronization frequency range: 10 Hz to 640 Hz																			
	<table border="1"> <thead> <tr> <th>Synchronization frequency (f) range</th> <th>Analysis order</th> </tr> </thead> <tbody> <tr> <td>10 Hz \leq f < 45 Hz</td> <td>50th</td> </tr> <tr> <td>45 Hz \leq f < 56 Hz</td> <td>50th</td> </tr> <tr> <td>56 Hz \leq f \leq 66 Hz</td> <td>50th</td> </tr> <tr> <td>66 Hz < f \leq 100 Hz</td> <td>50th</td> </tr> <tr> <td>100 Hz < f \leq 200 Hz</td> <td>40th</td> </tr> <tr> <td>200 Hz < f \leq 300 Hz</td> <td>25th</td> </tr> <tr> <td>300 Hz < f \leq 500 Hz</td> <td>15th</td> </tr> <tr> <td>500 Hz < f \leq 640 Hz</td> <td>11th</td> </tr> </tbody> </table>		Synchronization frequency (f) range	Analysis order	10 Hz \leq f < 45 Hz	50th	45 Hz \leq f < 56 Hz	50th	56 Hz \leq f \leq 66 Hz	50th	66 Hz < f \leq 100 Hz	50th	100 Hz < f \leq 200 Hz	40th	200 Hz < f \leq 300 Hz	25th	300 Hz < f \leq 500 Hz	15th	500 Hz < f \leq 640 Hz	11th
Synchronization frequency (f) range	Analysis order																			
10 Hz \leq f < 45 Hz	50th																			
45 Hz \leq f < 56 Hz	50th																			
56 Hz \leq f \leq 66 Hz	50th																			
66 Hz < f \leq 100 Hz	50th																			
100 Hz < f \leq 200 Hz	40th																			
200 Hz < f \leq 300 Hz	25th																			
300 Hz < f \leq 500 Hz	15th																			
500 Hz < f \leq 640 Hz	11th																			
Analysis order upper limit setting	2nd to 50th (default state: 50th)																			
Measurement accuracy	f.s.: Measurement range																			
	<table border="1"> <thead> <tr> <th>Frequency (f)</th> <th>Voltage, Current, Active power</th> </tr> </thead> <tbody> <tr> <td>DC</td> <td>$\pm 0.4\%$ rdg. $\pm 0.2\%$ f.s.</td> </tr> <tr> <td>10 Hz \leq f < 30 Hz</td> <td>$\pm 0.4\%$ rdg. $\pm 0.2\%$ f.s.</td> </tr> <tr> <td>30 Hz \leq f \leq 400 Hz</td> <td>$\pm 0.3\%$ rdg. $\pm 0.1\%$ f.s.</td> </tr> <tr> <td>400 Hz < f \leq 1 kHz</td> <td>$\pm 0.4\%$ rdg. $\pm 0.2\%$ f.s.</td> </tr> <tr> <td>1 kHz < f \leq 5 kHz</td> <td>$\pm 1.0\%$ rdg. $\pm 0.5\%$ f.s.</td> </tr> <tr> <td>5 kHz < f \leq 8 kHz</td> <td>$\pm 4.0\%$ rdg. $\pm 1.0\%$ f.s.</td> </tr> </tbody> </table>		Frequency (f)	Voltage, Current, Active power	DC	$\pm 0.4\%$ rdg. $\pm 0.2\%$ f.s.	10 Hz \leq f < 30 Hz	$\pm 0.4\%$ rdg. $\pm 0.2\%$ f.s.	30 Hz \leq f \leq 400 Hz	$\pm 0.3\%$ rdg. $\pm 0.1\%$ f.s.	400 Hz < f \leq 1 kHz	$\pm 0.4\%$ rdg. $\pm 0.2\%$ f.s.	1 kHz < f \leq 5 kHz	$\pm 1.0\%$ rdg. $\pm 0.5\%$ f.s.	5 kHz < f \leq 8 kHz	$\pm 4.0\%$ rdg. $\pm 1.0\%$ f.s.				
Frequency (f)	Voltage, Current, Active power																			
DC	$\pm 0.4\%$ rdg. $\pm 0.2\%$ f.s.																			
10 Hz \leq f < 30 Hz	$\pm 0.4\%$ rdg. $\pm 0.2\%$ f.s.																			
30 Hz \leq f \leq 400 Hz	$\pm 0.3\%$ rdg. $\pm 0.1\%$ f.s.																			
400 Hz < f \leq 1 kHz	$\pm 0.4\%$ rdg. $\pm 0.2\%$ f.s.																			
1 kHz < f \leq 5 kHz	$\pm 1.0\%$ rdg. $\pm 0.5\%$ f.s.																			
5 kHz < f \leq 8 kHz	$\pm 4.0\%$ rdg. $\pm 1.0\%$ f.s.																			
	<ul style="list-style-type: none"> When using the 1 mA/ 2 mA range Add $\pm 1 \mu\text{A}$ to 10 Hz to 8 kHz measurement accuracy for current. Add $(\pm 1 \mu\text{A}) \times (\text{voltage read value})$ to 10 Hz to 8 kHz measurement accuracy for active power. When using the 200 mA/ 500 mA/ 1 A/ 2 A/ 5 A/ 10 A/ 20 A range Add $\pm 1 \text{ mA}$ to DC measurement accuracy for current. Add $(\pm 1 \text{ mA}) \times (\text{voltage read value})$ to DC measurement accuracy for active power. When using the 1 mA/ 2 mA/ 5 mA/ 10 mA/ 20 mA/ 50 mA/ 100 mA range Add $\pm 10 \mu\text{A}$ to DC measurement accuracy for current. Add $(\pm 10 \mu\text{A}) \times (\text{voltage read value})$ to DC measurement accuracy for active power. 																			

D/A Output Specifications (included with PW3335-02 and PW3335-04, specify at time of order)

Number of output channels	7
Configuration	16-bit D/A converter (polarity + 15 bits)
Output parameters	<p>Output parameters for all channels Select from: Voltage, current, active power, apparent power, reactive power, power factor, phase angle, frequency, total harmonic voltage distortion, total harmonic current distortion, voltage crest factor, current crest factor, time average current, time average active power, voltage ripple rate, current ripple rate, current integration, active power integration, maximum current ratio The rectifier can be selected. Harmonic-order output is not supported.</p>
Output accuracy	<p>f.s.: Relative to the output voltage rated value for each output parameter Level output: (Output parameter measurement accuracy) + ($\pm 0.2\%$f.s.) High-speed level output: (Output parameter measurement accuracy) + ($\pm 0.2\%$f.s.) Waveform output: (Output parameter measurement accuracy) + ($\pm 1.0\%$f.s.) Instantaneous voltage, instantaneous current: RMS value level Instantaneous power: Average value level</p>
Output frequency band	<p>Waveform output, high-speed level output At DC or 10 Hz to 30 kHz, accuracy is as defined above.</p>
Conditions of guaranteed accuracy	<p>Temperature and humidity range : $23^{\circ}\text{C}\pm 5^{\circ}\text{C}$ ($73^{\circ}\text{F}\pm 9^{\circ}\text{F}$), 80% RH or less Warm-up time: 30 minutes, after zero-adjustment</p>
Output voltage	<p>The output level, output speed, and waveform output can be selected. Level output 2 Vf.s.(STD.2): ± 2 V DC at full scale (f.s.), linked to display updates Level output 5 Vf.s.(STD.5): ± 5 V DC at full scale (f.s.), linked to display updates High-speed level output 2 Vf.s.(FAST.2): ± 2 V DC at full scale (f.s.), linked to synchronization interval High-speed level output 5 Vf.s.(FAST.5) ± 5 V DC at full scale (f.s.), linked to synchronization interval Waveform output 1 Vf.s.(FAST): 1 V f.s. at full scale, linked to sampling</p> <p>Available selections vary with the output parameter. Voltage, current, active power Select from: STD.2/ STD.5/ FAST.2/ FAST.5/ FAST However, specifying FAST.2 or FAST.5 forcibly sets the rectifier to AC+DC. Apparent power, reactive power, power factor, phase angle, total harmonic voltage distortion, total harmonic current distortion, voltage ripple rate, current ripple rate, voltage crest factor, current crest factor, time average current, time average active power, maximum current ratio Select from: STD.2/ STD.5 Frequency, current integration, active power integration fixed to STD.5</p> <p>Full scale (f.s.) for the above parameters is as follows: Voltage, current, active power, apparent power, reactive power, time average current, time average active power: measurement range For time average current or time average active power, setting to TOTAL range causes current measurement range to be set to 20 A, and power measurement to voltage range $\times 20$ A. Power factor: ± 0.0000 (± 1.0000: DC0 V) Phase angle: $\pm 180.00^{\circ}$ Voltage ripple rate, current ripple rate, total harmonic voltage distortion, total harmonic current distortion: 100.00% Voltage crest factor, current crest factor: 10.000 Maximum current ratio: 10.000 Frequency: Selected from the following: 0.5 Hz/ 5 Hz/ 50 Hz/ 500 Hz/ 5 kHz/ 50 kHz/ 500 kHz Current integration, active power integration: Selected from the following: 5 m/ 50 m/ 500 m/ 5/ 50/ 500/ 5 k/ 50 k/ 500 k/ 5 M/ 50 M/ 500 M/ 5000 M [Ah/Wh]</p> <p>Error output: Level output of approx. ± 9 V DC is generated when the output parameter display is [o.r] or when the PEAK OVER U or PEAK OVER I lamp lights up. Output of 0 V is generated for [- - - -] (invalid data display).</p>

Maximum output voltage	Approx. ± 12 V DC
Output update rate	<p>Level output (STD.2/ STD.5): Same as the data update period. Update rate is unrelated to number of averaging iterations setting and display hold operation.</p> <p>High-speed level output (FAST.2/ FAST.5):</p> <p>AC Updated once every cycle for the input waveform set as the synchronization source. However, voltage and current are only updated once every cycle for input signals from 45 to 66 Hz.</p> <p>DC Updated at the set timeout time interval.</p> <p>Waveform output (FAST): Approx. 1.43 μs (approx. 700 kHz)</p>
Response time	<p>Level output (STD.2/ STD.5): 0.6 sec. or less (when the input changes abruptly from 0% to 90%, or from 100% to 10%, the time required in order to satisfy the accuracy range with a synchronization timeout setting of 0.1 s)</p> <p>High-speed level output: (FAST.2/ FAST.5) 2 ms or less</p> <p>Waveform output (FAST): 0.2 ms or less</p>
Temperature coefficient	$\pm 0.05\%$ f.s./ $^{\circ}$ C or less
Output resistance	100 Ω ± 5 Ω
Default state	<p>D/A channel 1 U, AC+DC, STD.2 (voltage level, STD.2)</p> <p>D/A channel 2 I, AC+DC, STD.2 (current level, STD.2)</p> <p>D/A channel 3 P, AC+DC, STD.2 (active power level, STD.2)</p> <p>D/A channel 4 λ, AC+DC, STD.2 (power factor, STD.2)</p> <p>D/A channel 5 u, FAST (instantaneous voltage waveform)</p> <p>D/A channel 6 i, FAST (instantaneous current waveform)</p> <p>D/A channel 7 p, FAST (instantaneous power waveform)</p> <p>Frequency f.s. 500 Hz</p> <p>Integrated values f.s. 5 k [Ah/Wh]</p>

External Current Sensor Input Specifications (CURRENT SENSOR) (included with PW3335-03 and PW3335-04, specify at time of order)

Terminal	Isolated BNC terminals
Input method	Isolated input from a voltage-output current sensor (instrument's external current sensor input terminals are not isolated)
Maximum input voltage	8 V, ± 12 V peak
Input resistance	287 k Ω \pm 10 k Ω
Current sensor type switching	OFF / TYPE.1 / TYPE.2 When set to off, input from the external current sensor input terminal is ignored.
Current sensor options	Supported current sensors TYPE.1 9661 Clamp on Sensor (rating: 500 A AC) 9669 Clamp on Sensor (rating: 1,000 A AC) 9660 Clamp on Sensor (rating: 100 A AC) CT9667 Flexible Clamp on Sensor (rating: 500 A / 5,000 A AC) TYPE.2 9555-10 Sensor Unit L9217 Connection Cord 9272-10 Clamp on Sensor (rating: 20 A / 200 A AC) 9277 Universal Clamp on CT (rating: 20 A AC/DC) 9278 Universal Clamp on CT (rating: 200 A AC/DC) 9279 Universal Clamp on CT (rating: 500 A AC/DC) 9709 AC/DC Current Sensor (rating: 500 A AC/DC) CT6862 AC/DC Current Sensor (rating: 50 A AC/DC) CT6863 AC/DC Current Sensor (rating: 200 A AC/DC) CT6865 AC/DC Current Sensor (rating: 1,000 A AC/DC) CT6841 AC/DC Current Probe (rating: 20 A AC/DC) CT6843 AC/DC Current Probe (rating: 200 A AC/DC)
Current measurement range	AUTO/ 1 A/ 2 A/ 5 A (range noted on panel) Can be read directly by manually setting the CT ratio.
Constraints	Auto-range integration not supported.
Default state	External current sensor: OFF, current measurement range: 5 A, AUTO range: OFF

Power range configuration

When using a current sensor with a rating of 20 A (with the CT ratio set to 4)
9272-10 (20 A): TYPE.2; 9277: TYPE.2; CT6841: TYPE.2

Range noted on panel	Current range	Voltage range							
		6.0000 V	15.000 V	30.000 V	60.000 V	150.00 V	300.00 V	600.00 V	1.0000 kV
1 A	4.0000 A	24.000	60.000	120.00	240.00	600.00	1.2000 k	2.4000 k	4.0000 k
2 A	8.0000 A	48.000	120.00	240.00	480.00	1.2000 k	2.4000 k	4.8000 k	8.0000 k
5 A	20.000 A	120.00	300.00	600.00	1.2000 k	3.0000 k	6.0000 k	12.000 k	20.000 k

Units: W (active power), VA (apparent power), var (reactive power)

When using a current sensor with a rating of 50 A (with the CT ratio set to 10)
CT6862: TYPE.2

Range noted on panel	Current range	Voltage range							
		6.0000 V	15.000 V	30.000 V	60.000 V	150.00 V	300.00 V	600.00 V	1.0000 kV
1 A	10.000 A	60.000	150.00	300.00	600.00	1.5000 k	3.0000 k	6.0000 k	10.000 k
2 A	20.000 A	120.00	300.00	600.00	1.2000 k	3.0000 k	6.0000 k	12.000 k	20.000 k
5 A	50.000 A	300.00	750.00	1.5000 k	3.0000 k	7.5000 k	15.000 k	30.000 k	50.000 k

Units: W (active power), VA (apparent power), var (reactive power)

When using a current sensor with a rating of 200 A (with the CT ratio set to 40)
9272-10 (200 A): TYPE.2; 9278: TYPE.2; CT6863: TYPE.2; CT6843: TYPE.2

Range noted on panel	Current range	Voltage range							
		6.0000 V	15.000 V	30.000 V	60.000 V	150.00 V	300.00 V	600.00 V	1.0000 kV
1 A	40.000 A	240.00	600.00	1.2000 k	2.4000 k	6.0000 k	12.000 k	24.000 k	40.000 k
2 A	80.000 A	480.00	1.2000 k	2.4000 k	4.8000 k	12.000 k	24.000 k	48.000 k	80.000 k
5 A	200.00 A	1.2000 k	3.0000 k	6.0000 k	12.000 k	30.000 k	60.000 k	120.00 k	200.00 k

Units: W (active power), VA (apparent power), var (reactive power)

When using a current sensor with a rating of 500 A (with the CT ratio set to 100)
9661: TYPE.1; CT9667 (500 A): TYPE.1; 9279: TYPE.2; 9709: TYPE.2

Range noted on panel	Current range	Voltage range							
		6.0000 V	15.000 V	30.000 V	60.000 V	150.00 V	300.00 V	600.00 V	1.0000 kV
1 A	100.00 A	600.00	1.5000 k	3.0000 k	6.0000 k	15.000 k	30.000 k	60.000 k	100.00 k
2 A	200.00 A	1.2000 k	3.0000 k	6.0000 k	12.000 k	30.000 k	60.000 k	120.00 k	200.00 k
5 A	500.00 A	3.0000 k	7.5000 k	15.000 k	30.000 k	75.000 k	150.00 k	300.00 k	500.00 k

Units: W (active power), VA (apparent power), var (reactive power)

When using a current sensor with a rating of 1,000 A (with the CT ratio set to 200)
9669: TYPE.1; CT6865: TYPE.2

Range noted on panel	Current range	Voltage range							
		6.0000 V	15.000 V	30.000 V	60.000 V	150.00 V	300.00 V	600.00 V	1.0000 kV
1 A	200.00 A	1.2000 k	3.0000 k	6.0000 k	12.000 k	30.000 k	60.000 k	120.00 k	200.00 k
2 A	400.00 A	2.4000 k	6.0000 k	12.000 k	24.000 k	60.000 k	120.00 k	240.00 k	400.00 k
5 A	1.0000 kA	6.0000 k	15.000 k	30.000 k	60.000 k	150.00 k	300.00 k	600.00 k	1.0000 M

Units: W (active power), VA (apparent power), var (reactive power)

When using a current sensor with a rating of 5,000 A (with the CT ratio set to 1000)
CT9667 (5,000 A): TYPE.1

Range noted on panel	Current range	Voltage range							
		6.0000 V	15.000 V	30.000 V	60.000 V	150.00 V	300.00 V	600.00 V	1.0000 kV
1 A	1.0000 kA	6.0000 k	15.000 k	30.000 k	60.000 k	150.00 k	300.00 k	600.00 k	1.0000 M
2 A	2.0000 kA	12.000 k	30.000 k	60.000 k	120.00 k	300.00 k	600.00 k	1.2000 M	2.0000 M
5 A	5.0000 kA	30.000 k	75.000 k	150.00 k	300.00 k	750.00 k	1.5000 M	3.0000 M	5.0000 M

Units: W (active power), VA (apparent power), var (reactive power)

When using the 9660 (TYPE.1) (rated current: 100 A; with the CT ratio set to 100)

Range noted on panel	Current range	Voltage range							
		6.0000 V	15.000 V	30.000 V	60.000 V	150.00 V	300.00 V	600.00 V	1.0000 kV
1 A	100.00A	600.00	1.5000 k	3.0000 k	6.0000 k	15.000 k	30.000 k	60.000 k	100.00 k

Units: W (active power), VA (apparent power), var (reactive power)

5.3 Measurement specifications

Measurement accuracy External current sensor input instrument measurement accuracy only
Voltage

Frequency (f)	Input < 50%f.s.	50%f.s. ≤ Input < 100%f.s.	100%f.s. ≤ Input
DC	±0.1% rdg.±0.1%f.s.	±0.1% rdg.±0.1%f.s.	±0.2% rdg.
0.1 Hz ≤ f < 16 Hz	±0.1% rdg.±0.2%f.s.	±0.3% rdg.	±0.3% rdg.
16 Hz ≤ f < 45 Hz	±0.1% rdg.±0.1%f.s.	±0.2% rdg.	±0.2% rdg.
45 Hz ≤ f ≤ 66 Hz	±0.1% rdg.±0.05%f.s.	±0.15% rdg.	±0.15% rdg.
66 Hz < f ≤ 500 Hz	±0.1% rdg.±0.1%f.s.	±0.2% rdg.	±0.2% rdg.
500 Hz < f ≤ 10 kHz	±0.1% rdg.±0.2%f.s.	±0.3% rdg.	±0.3% rdg.
10 kHz < f ≤ 50 kHz	±0.5% rdg.±0.3%f.s.	±0.8% rdg.	±0.8% rdg.
50 kHz < f ≤ 100 kHz	±2.1% rdg.±0.3%f.s.	±2.4% rdg.	±2.4% rdg.

Current (external current sensor input)

Frequency (f)	Input < 50%f.s.	50%f.s. ≤ Input < 100%f.s.	100%f.s. ≤ Input
DC	±0.1% rdg.±0.2%f.s.	±0.1% rdg.±0.2%f.s.	±0.3% rdg.
0.1 Hz ≤ f < 16 Hz	±0.1% rdg.±0.2%f.s.	±0.3% rdg.	±0.3% rdg.
16 Hz ≤ f < 45 Hz	±0.1% rdg.±0.2%f.s.	±0.3% rdg.	±0.3% rdg.
45 Hz ≤ f ≤ 66 Hz	±0.1% rdg.±0.1%f.s.	±0.2% rdg.	±0.2% rdg.
66 Hz < f ≤ 500 Hz	±0.1% rdg.±0.2%f.s.	±0.3% rdg.	±0.3% rdg.
500 Hz < f ≤ 1 kHz	±0.1% rdg.±0.2%f.s.	±0.3% rdg.	±0.3% rdg.
1 kHz < f ≤ 10 kHz	±(0.03+0.07×F)% rdg.±0.2%f.s.	±(0.23+0.07×F)% rdg.	±(0.23+0.07×F)% rdg.
10 kHz < f ≤ 100 kHz	±(0.3+0.04×F)% rdg.±0.3%f.s.	±(0.6+0.04×F)% rdg.	±(0.6+0.04×F)% rdg.

Active power

Frequency (f)	Input < 50%f.s.	50%f.s. ≤ Input < 100%f.s.	100%f.s. ≤ Input
DC	±0.1% rdg.±0.2%f.s.	±0.1% rdg.±0.2%f.s.	±0.3% rdg.
0.1 Hz ≤ f < 16 Hz	±0.1% rdg.±0.2%f.s.	±0.3% rdg.	±0.3% rdg.
16 Hz ≤ f < 45 Hz	±0.1% rdg.±0.2%f.s.	±0.3% rdg.	±0.3% rdg.
45 Hz ≤ f ≤ 66 Hz	±0.1% rdg.±0.1%f.s.	±0.2% rdg.	±0.2% rdg.
66 Hz < f ≤ 500 Hz	±0.1% rdg.±0.2%f.s.	±0.3% rdg.	±0.3% rdg.
500 Hz < f ≤ 1 kHz	±0.1% rdg.±0.2%f.s.	±0.3% rdg.	±0.3% rdg.
1 kHz < f ≤ 10 kHz	±(0.03+0.07×F)% rdg.±0.2%f.s.	±(0.23+0.07×F)% rdg.	±(0.23+0.07×F)% rdg.
10 kHz < f ≤ 50 kHz	±(0.07×F)% rdg.±0.3%f.s.	±(0.3+0.07×F)% rdg.	±(0.3+0.07×F)% rdg.
50 kHz < f ≤ 100 kHz	±(0.6+0.07×F)% rdg.±0.3%f.s.	±(0.9+0.07×F)% rdg.	±(0.9+0.07×F)% rdg.

- Values for f.s. depend on measurement ranges.
- “F” in the tables refers to the frequency in kHz.
- To obtain the current or active power accuracy, add the current sensor’s accuracy to the above current and active power accuracy figures.
- The effective measurement range and frequency characteristics conform to the current sensor’s specifications.
- The following input are considered reference values:
Values for voltage, current, and active power for which $0.1 \text{ Hz} \leq f < 10 \text{ Hz}$.
Values for voltage and active power in excess of 220 V for which $10 \text{ Hz} \leq f < 16 \text{ Hz}$.
Values for voltage and active power in excess of 750 V for which $30 \text{ kHz} < f \leq 100 \text{ kHz}$.
- When using the CT6841/CT6843, add ±2 mV to the CT6841/CT6843 accuracy after performing CT6841/CT6843 zero adjustment using the 1 A range noted on the panel.

Current effective measuring range

±1% to ±150% of the range. However, the effective measurement range depends on the current sensor’s specifications.

Maximum effective peak current

The following data reflects the specifications of the instrument alone. In fact, the maximum effective peak current depends on the current sensor’s specifications.

TYPE.1: ±600% of each current range

TYPE.2: ±600% of each current range

However, the maximum effective peak current is limited to ±400% for the 5 A range noted on the panel.

Peak exceeded warning

If the maximum effective peak current is exceeded, the **PEAK OVER I** lamp will light up.

Temperature coefficient Voltage: $\pm 0.03\%$ f.s./ $^{\circ}\text{C}$ or less
 Current, active power: $\pm 0.08\%$ f.s./ $^{\circ}\text{C}$ or less (instrument temperature coefficient; f.s.: instrument measurement range)
 Add current sensor temperature coefficient to above.

Effect of power factor Instrument: $\pm 0.15\%$ f.s. or less (45 to 66 Hz with power factor = 0)
 Internal circuit voltage/current phase difference: $\pm 0.0859^{\circ}$
 Add the current sensor phase accuracy to the internal circuit voltage/current phase difference noted above.

Current waveform peak value measurement specifications External current sensor input-specific specifications only
 Measurement accuracy
 $\pm 2.0\%$ at DC or $10\text{ Hz} \leq f \leq 1\text{ kHz}$ (f.s.: current peak range)
 Reference value given for $0.1\text{ Hz} \leq f < 10\text{ Hz}$ and $1\text{ kHz} < f$.
 Add the current sensor accuracy to the above.
 Measurement range

Current range noted on panel	1 A	2 A	5 A
Current range	1 A \times CT ratio	2 A \times CT ratio	5 A \times CT ratio
Current peak range	(1 A \times CT ratio) \times 6	(2 A \times CT ratio) \times 6	(5 A \times CT ratio) \times 6

Effective measuring range

$\pm 5\%$ to $\pm 100\%$ of current peak range

However, when using the 5 A range noted on the panel for TYPE.2, the upper limit is $\pm 66.666\%$ of the current peak range ($\pm 400\%$ of the current range).

Harmonic measurement accuracy External current sensor input instrument measurement accuracy only

Frequency (f)	Voltage, Current, Active power
DC	$\pm 0.4\%$ rdg. $\pm 0.2\%$ f.s.
$10\text{ Hz} \leq f < 30\text{ Hz}$	$\pm 0.4\%$ rdg. $\pm 0.2\%$ f.s.
$30\text{ Hz} \leq f \leq 400\text{ Hz}$	$\pm 0.3\%$ rdg. $\pm 0.1\%$ f.s.
$400\text{ Hz} < f \leq 1\text{ kHz}$	$\pm 0.4\%$ rdg. $\pm 0.2\%$ f.s.
$1\text{ kHz} < f \leq 5\text{ kHz}$	$\pm 1.0\%$ rdg. $\pm 0.5\%$ f.s.
$5\text{ kHz} < f \leq 8\text{ kHz}$	$\pm 4.0\%$ rdg. $\pm 1.0\%$ f.s.

- Values for f.s. depend on measurement ranges.
- To obtain the current or active power accuracy, add the current sensor's accuracy to the above current and active power accuracy figures.
- When using the CT6841/CT6843, add $\pm 2\text{ mV}$ to the CT6841/CT6843 accuracy after performing CT6841/CT6843 zero adjustment using the 1 A range noted on the panel.

5.4 Functional Specifications

Auto-range (AUTO)

Functions	Automatically changes the voltage and current range according to the input.
Operation	<p>Pressing the AUTO key turns on the auto-range function (causing the AUTO lamp to light up). Pressing the AUTO key again turns the auto-range function off, as does pressing any range key (causing the AUTO lamp to turn off).</p> <p>Range up: The range is increased when input exceeds 150% of the range or when the peak is exceeded.</p> <p>Range down: The range is decreased when input falls below 15% of the range. However, the range is not decreased when the peak is exceeded at the lower range.</p> <p>The input level is monitored, and the range is switched over multiple ranges. Range select can be used to disable ranges so that they are not selected.</p>
Default state	Voltage/ current AUTO range: OFF

Range select and zero-cross filter's threshold level settings

Functions	<p>Selects whether to enable (turn on) or disable (turn off) individual voltage and current ranges.</p> <p>Sets the zero-cross filter's threshold level for voltage and current ranges.</p>
Range select	<p>Enabled (use): Ranges can be selected with the range keys. Range switching occurs using auto-range operation. Range switching occurs during auto-range integration.</p> <p>Disabled (do not use): Ranges cannot be selected with the range keys. Range switching does not occur using auto-range operation. Range switching does not occur during auto-range integration.</p>
Zero-cross filter's threshold level	Set from 1% to 15% (in 1% intervals).
Display	When there is a range that has been disabled or for which the zero-cross threshold level is a value other than 1%: The RANGE SEL lamp will light up.
Default state	All voltage and current ranges.: ON, zero-cross filter's threshold level: 1%

Averaging (AVG)

Functions	<p>Averages the voltage, current, active power, apparent power, and reactive power. (Other than harmonic measurement parameters.)</p> <p>The power factor and phase angle are calculated from averaged data.</p> <p>Averaging is not performed for parameters other than those listed above.</p>																
Method	Simple averaging																
Number of averaging iterations and display update interval	<table border="1"> <tr> <td>Number of averaging iterations</td> <td>1 (OFF)</td> <td>2</td> <td>5</td> <td>10</td> <td>25</td> <td>50</td> <td>100</td> </tr> <tr> <td>Display update interval</td> <td>200 ms</td> <td>400 ms</td> <td>1 s</td> <td>2 s</td> <td>5 s</td> <td>10 s</td> <td>20 s</td> </tr> </table>	Number of averaging iterations	1 (OFF)	2	5	10	25	50	100	Display update interval	200 ms	400 ms	1 s	2 s	5 s	10 s	20 s
Number of averaging iterations	1 (OFF)	2	5	10	25	50	100										
Display update interval	200 ms	400 ms	1 s	2 s	5 s	10 s	20 s										
Display	The AVG lamp will light up when the number of averaging iterations is set to a value other than 1 (off). From the start of averaging until the first average value is displayed, the AVG lamp will flash, and all measured values will be shown as [- - - -] (invalid data).																
Over-range warning	When the data being averaged includes an [o.r] value, the corresponding unit will flash.																
Start of averaging	<p>Averaging is started or restarted at the following times:</p> <ol style="list-style-type: none"> 1. After the instrument starts up 2. After zero-adjustment operation is complete. 3. After settings related to averaging, for example the number of averaging iterations or the range, are changed 																
Default state	Number of averaging iterations: 1 (OFF)																

Scaling (VT, CT)

Functions	Applies user-defined VT and CT ratio settings to measured values.
VT ratio setting range	OFF (1.0) 0.001 to 0.009, 0.010 to 0.099, 0.100 to 0.999, 1.000 to 9.999, 10.00 to 99.99, 100.0 to 999.9, 1000. (setting: 0)
CT ratio setting range	OFF (1.0) 0.001 to 0.009, 0.010 to 0.099, 0.100 to 0.999, 1.000 to 9.999, 10.00 to 99.99, 100.0 to 999.9, 1000. (setting: 0)
Display	The VT lamp will turn on when the VT ratio is set to any value other than 1 (off). The CT lamp will turn on when the CT ratio is set to any value other than 1 (off).
Error warnings	The display will show S.Err (scaling error) when the VT ratio or CT ratio setting causes the full-scale value for active power, apparent power, or reactive power to exceed 99,999 M.
Default state	VT ratio: 1.0 (OFF), CT ratio: 1.0 (OFF)

Hold functions

Hold (HOLD)

Functions	<ul style="list-style-type: none"> Stops display updates for all measured values and fixes the display values at that point in time. Measurement data acquired by communications is also fixed at that point in time. Peak exceeded and other warning lamps will still light up. Internal calculations (including integration and integration elapsed time) will continue. Analog output and waveform output are not held. 																																				
Operation	Pressing the HOLD key turns on the hold function (and causes the HOLD lamp to light up). Pressing the HOLD key again turns off the hold function (causing the HOLD lamp to turn off).																																				
Default state	Hold display: OFF																																				
Backup	The hold function is backed up. (The hold value is not backed up, and display of the initial data is held when the instrument starts up.)																																				
Constraints	<p>During hold operation, the following operational constraints apply:</p> <p style="text-align: right;">●: Setting and changes allowed -: Setting and changes not allowed</p> <table border="1"> <thead> <tr> <th>Item</th> <th>During hold operation</th> </tr> </thead> <tbody> <tr> <td>Measurement range</td> <td>– However, during auto-range integration, auto-range operation is used to determine the current range.</td> </tr> <tr> <td>Current input method switching</td> <td>–</td> </tr> <tr> <td>Frequency measurement range (Zero-cross filter)</td> <td>–</td> </tr> <tr> <td>Timeout</td> <td>–</td> </tr> <tr> <td>Integration time</td> <td>–</td> </tr> <tr> <td>Synchronization source</td> <td>–</td> </tr> <tr> <td>Zero-adjustment</td> <td>–</td> </tr> <tr> <td>Maximum value/minimum value hold</td> <td>●</td> </tr> <tr> <td>Display parameters</td> <td>●</td> </tr> <tr> <td>D/A output parameters</td> <td>●</td> </tr> <tr> <td>Number of averaging iterations</td> <td>–</td> </tr> <tr> <td>VT ratio</td> <td>–</td> </tr> <tr> <td>CT ratio</td> <td>–</td> </tr> <tr> <td>RS-232C transfer speed</td> <td>●</td> </tr> <tr> <td>GP-IB address</td> <td>●</td> </tr> <tr> <td>LAN</td> <td>●</td> </tr> <tr> <td>Harmonic analysis order upper limit</td> <td>–</td> </tr> </tbody> </table>	Item	During hold operation	Measurement range	– However, during auto-range integration, auto-range operation is used to determine the current range.	Current input method switching	–	Frequency measurement range (Zero-cross filter)	–	Timeout	–	Integration time	–	Synchronization source	–	Zero-adjustment	–	Maximum value/minimum value hold	●	Display parameters	●	D/A output parameters	●	Number of averaging iterations	–	VT ratio	–	CT ratio	–	RS-232C transfer speed	●	GP-IB address	●	LAN	●	Harmonic analysis order upper limit	–
Item	During hold operation																																				
Measurement range	– However, during auto-range integration, auto-range operation is used to determine the current range.																																				
Current input method switching	–																																				
Frequency measurement range (Zero-cross filter)	–																																				
Timeout	–																																				
Integration time	–																																				
Synchronization source	–																																				
Zero-adjustment	–																																				
Maximum value/minimum value hold	●																																				
Display parameters	●																																				
D/A output parameters	●																																				
Number of averaging iterations	–																																				
VT ratio	–																																				
CT ratio	–																																				
RS-232C transfer speed	●																																				
GP-IB address	●																																				
LAN	●																																				
Harmonic analysis order upper limit	–																																				

External control

Input signal level 0 to 5 V (high-speed CMOS level) or shorted (low)/open (high)

Functions	External control signal	External control terminal
Hold on	Hi → Lo	HOLD
Hold off (canceled)	Lo → Hi	

Maximum value/ minimum value hold (MAX/MIN HOLD)**Functions**

- Detects maximum and minimum measured values (except current integration, active power integration, integration elapsed time, time average current, and time average active power values) as well as maximum and minimum values for the voltage waveform peak and current waveform peak and holds them on the display.
- For data with polarity, display of the maximum value and minimum value for the data's absolute values is held (so that both positive and negative polarity values are shown). However, this does not apply to the voltage waveform peak value or the current waveform peak value.
- Peak exceeded and other warning lamps will still light up.
- Internal calculations (including integration and integration elapsed time) will continue.
- The maximum and minimum values during integration are detected (maximum/minimum value measurement during the integration interval).
- Analog output and waveform output are not held.

Maximum value and minimum value detection operation

1. After the instrument starts up, internal data is cleared, and detection operation restarts. (However, if the instrument was restarted while integration was in progress, the display will indicate [----] [invalid data].)
2. Internal data is cleared and detection restarts when the **DATA RESET** key is pressed (including via external control).
3. Internal data is cleared and detection restarts when integration is started.
4. Detection of maximum and minimum values stops when integration stops.
5. Operation does not resume when the range is changed.
6. If the VT ratio or CT ratio is changed, detection operation restarts.

Display switching

Pressing the **MAX/ MIN** key cycles the display as follows: Maximum value → minimum value → instantaneous value (causing the **MAX** and **MIN** lamp to light up as appropriate).

Default state

Maximum value/minimum value hold display: OFF

Backup

The maximum value/ minimum value hold function is backed up. (Maximum and minimum values are not backed up, and detection operation restarts when the instrument starts up.)

Constraints

During the maximum value and minimum value hold display, the following operational constraints apply:

●: Setting and changes allowed –: Setting and changes not allowed

Item	During maximum value/ minimum value hold display
Measurement range	●
Current input method switching	–
Frequency measurement range (Zero-cross filter)	–
Timeout	–
Integration time	–
Synchronization source	–
Zero Adjustment	–
Hold	–
Display parameters	●
D/A output parameters	●
Number of averaging iterations	–
VT ratio	–
CT ratio	–
RS-232C transfer speed	●
GP-IB address	●
LAN	●
Harmonic analysis order upper limit	–

Zero Adjustment (0 ADJ)

Functions	Zeroes out the voltage and current input offset.
Compensation range	Voltage: $\pm 15\%$ f.s. or less Current: $\pm 15\%$ f.s. or less External current sensor input: $\pm 15\%$ f.s. or less
Compensation operation time	Approx. 30 sec.
Method	Press the 0 ADJ key.
Constraints	Zero-adjustment is performed regardless of the current input method. No measured values are displayed during zero-adjustment. Integration cannot be started during zero-adjustment. Zero-adjustment cannot be performed during integration. Zero-adjustment cannot be performed during display hold or maximum value or minimum value hold operation. Settings cannot be changed during zero-adjustment. After zero-adjustment completes, averaging is cleared and restarted.

Synchronized control

Functions	The timing of calculations; display updates; data updates; integration start, stop, and reset events; display hold operation; key lock operation; and zero-adjustment operation for the slave PW3335, PW3335-01, PW3335-02, PW3335-03, or PW3335-04 is synchronized with the master PW3335, PW3335-01, PW3335-02, PW3335-03, or PW3335-04. Synchronization with the PW3336, PW3336-01, PW3336-02, PW3336-03, PW3337, PW3337-01, PW3337-02, and PW3337-03 is also supported. An error will be displayed if unable to perform synchronized control (and the display will continue until the error is cleared).
Terminal	BNC terminal $\times 1$ (non-isolated)
Terminal name	External synchronization terminal (EXT.SYNC)
I/O settings	OFF/ In/ OUT OFF: Synchronized control function off (signals input to the external synchronization terminal (EXT.SYNC) are ignored) IN: The external synchronization terminal (EXT.SYNC) is set to input, and a dedicated synchronization signal can be input (slave). The SYNC. OUT lamp will flash when a synchronization signal is received. OUT: The external synchronization terminal (EXT.SYNC) is set to output, and a dedicated synchronization signal can be output (master). The SYNC. OUT lamp will light up when the terminal is set to OUT.
I/O signal levels	High level: +5 V; low level: 0 V (high-speed CMOS level)
Number of units for which synchronized control can be performed	Up to 7 slaves per master (total of 8 units including the PW3336/PW3337 series)
Default state	Synchronized control: OFF

Key-lock (KEY LOCK)

Functions	Disables key input in the measurement state, except for the KEY LOCK key.
Operation	Pressing the KEY LOCK key enables the key lock function (causing the KEY LOCK lamp to light up).
Constraints	The key lock state will be canceled when the instrument is placed in the remote state (and the REMOTE lamp will light up) by communications.
Backup	Yes (The key lock state will continue in effect when the instrument starts up.)
Default state	Key-lock: OFF

Backup

Functions	Backs up settings and integration data if the instrument is turned off and if a power outage occurs.
------------------	--

System Reset

Functions	Initializes the instrument's settings.
Operation	The system will be reset if the DATA RESET key is pressed after the instrument is turned on.
Constraints	Communications-related settings (communications speed, address, and LAN-related settings) are not initialized.

Instrument protection mode

Functions	<p>Forcibly changes the range to the 200 mA range to prevent the instrument's current input circuitry from producing heat if current of greater than or equal to ± 612 mA peak is inputted continuously for 10 or more seconds when using a range from 1 mA to 100 mA with fixed range.</p> <p>When using a range from the 200 mA range to the 20 A range, the user is prevented from switching to a range from the 1 mA to the 100 mA range while inputting a current that is greater than or equal to ± 612 mA peak.</p>
Operation	<p>The CURRENT ● lamp will flash.</p> <p>Integration will be forcibly stopped (causing the RUN lamp to flash), and it will not be possible to resume integration operation.</p> <p>Other functions can be used.</p> <p>If the 200 mA range has been disabled using the range select function, the range will be switched to an enabled range greater than the 200 mA range.</p>
Cancellation method	<p>Instrument protection mode can be canceled as described by performing any of the following actions, causing the CURRENT ● lamp to turn off:</p> <ol style="list-style-type: none"> 1. Pressing one of the current range keys 2. If integration has stopped, resetting integrated values 3. If integration has been reset, pressing the EXIT key 4. Performing a system reset 5. Performing zero-adjustment

5.5 Calculation Formulas Specifications

Basic measurement parameter calculation formulas

(1) Voltage calculation formulas

Item (RECTIFIER)	Calculation formulas
RMS value (AC+DC)	$U = \sqrt{\frac{1}{M} \sum_{s=0}^{M-1} (u_s)^2}$
Average value rectification RMS value converted value (AC+DC U_{mn})	$U_{mn} = \frac{\pi}{2\sqrt{2}} \frac{1}{M} \sum_{s=0}^{M-1} u_s $
Simple average value (DC)	$U_{DC} = \frac{1}{M} \sum_{s=0}^{M-1} u_s$
AC component RMS value (AC)	$U_{AC} = \sqrt{(U)^2 - (U_{DC})^2}$
Fundamental wave component RMS value (FND)	U_1 from harmonic calculation formula
Waveform peak value	$U_{pk} = \begin{cases} U_{pk+} : u_s & \text{Maximum value from M values} \\ U_{pk-} : u_s & \text{Minimum value from M values} \end{cases}$ <p>Displays the maximum absolute value from the above with its polarity.</p>
Total harmonic distortion	U_{thd} from harmonic calculation formula
Ripple rate	$U_{rf} = \frac{ (U_{pk+} - U_{pk-}) }{2 \times U_{DC} } \times 100$
Crest factor	$U_{cf} = \left \frac{U_{pk}}{U} \right $
M: Number of samples between synchronized timing points; s: Sample point number	

(2) Current calculation formulas

Item (RECTIFIER)	Calculation formulas
RMS value (AC+DC)	$I = \sqrt{\frac{1}{M} \sum_{s=0}^{M-1} (i_s)^2}$
Simple average value (DC)	$I_{DC} = \frac{1}{M} \sum_{s=0}^{M-1} i_s$
AC component RMS value (AC)	$I_{AC} = \sqrt{(I)^2 - (I_{DC})^2}$
Fundamental wave component RMS value (FND)	I_1 from harmonic calculation formula
Waveform peak value	$I_{pk} = \begin{cases} I_{pk+} : i_s & \text{Maximum value from M values} \\ I_{pk-} : i_s & \text{Minimum value from M values} \end{cases}$ <p>Displays the maximum absolute value from the above with its polarity.</p>
Total harmonic distortion	I_{thd} from harmonic calculation formula
Ripple rate	$I_{rf} = \frac{ (I_{pk+} - I_{pk-}) }{2 \times I_{DC} } \times 100$
Crest factor	$I_{cf} = \left \frac{I_{pk}}{I} \right $
Maximum current ratio	$MCR = \left \frac{I_{cf}}{\lambda} \right $
M: Number of samples between synchronization timing points; s: Sample point number	

(3) Power calculation formulas

Item (RECTIFIER)	Calculation formulas
Active power (AC+DC, AC+DC Umn)	$P = \frac{1}{M} \sum_{s=0}^{M-1} (u_s \times i_s)$
Active power simple average value (DC)	$P_{DC} = U_{DC} \times I_{DC}$
Active power AC component (AC)	$P_{AC} = P - P_{DC}$
Fundamental wave active power (FND)	P_1 from harmonic calculation formula
Apparent power (AC+DC, AC, AC+DC Umn)	$S = U \times I$
	Calculated values from the respective rectifiers are used for U and I . (For AC+DC Umn, the AC+DC value is used for current.)
Fundamental wave apparent power (FND)	S_1 from harmonic calculation formula
Reactive power (AC+DC, AC, AC+DC Umn)	$Q =_{si} \sqrt{S^2 - P^2}$
	Calculated values from the respective rectifiers are used for P and S .
Fundamental wave reactive power (FND)	Q_1 from harmonic calculation formula
Power factor (AC+DC, AC, AC+DC Umn)	$\lambda =_{si} \left \frac{P}{S} \right $
	Calculated values from the respective rectifiers are used for P and S .
Fundamental wave power factor (FND)	λ_1 from harmonic calculation formula
Phase angle (AC)	When $P_{AC} \geq 0$ $\varphi =_{si} \cos^{-1} \left \lambda \right \quad (0^\circ \sim \pm 90^\circ)$
	When $P_{AC} < 0$ $\varphi =_{si} \left 180 - \cos^{-1} \left \lambda \right \right \quad (\pm 90^\circ \sim \pm 180^\circ)$
	Calculated values from the respective rectifiers are used for λ .
Fundamental wave voltage current phase difference (FND)	φ_1 from harmonic calculation formula
M: Number of samples between synchronized timing points; s: Number of sample points; si: Polarity symbol, acquired based on voltage waveform and current waveform lead and lag Symbol [None]: Current lags voltage (LAG). Symbol [-]: Current leads voltage (LEAD).	

(4) Harmonic measurement parameter calculation formulas

Item	Calculation formulas
Harmonic voltage	$U_k = \sqrt{(U_{kr})^2 + (U_{ki})^2}$
Harmonic voltage content percentage	$U_{HDk} = \frac{U_k}{U_1} \times 100$
Harmonic voltage phase angle	$\theta U_k = \tan^{-1}\left(\frac{U_{kr}}{-U_{ki}}\right)$
Total harmonic voltage distortion	$U_{thd} = \frac{\sqrt{\sum_{k=2}^K (U_k)^2}}{U_1} \times 100$
Harmonic current	$I_k = \sqrt{(I_{kr})^2 + (I_{ki})^2}$
Harmonic current content percentage	$I_{HDk} = \frac{I_k}{I_1} \times 100$
Harmonic current phase angle	$\theta I_k = \tan^{-1}\left(\frac{I_{kr}}{-I_{ki}}\right)$
Total harmonic current distortion	$I_{thd} = \frac{\sqrt{\sum_{k=2}^K (I_k)^2}}{I_1} \times 100$
Harmonic active power	$P_k = U_{kr} \times I_{kr} + U_{ki} \times I_{ki}$
Harmonic active power content percentage	$P_{HDk} = \frac{P_k}{P_1} \times 100$
Fundamental wave voltage current phase difference	$\varphi_1 = (\theta I_1 - \theta U_1) \times (-1)$
Harmonic voltage current phase difference	$\varphi_k = (\theta I_k - \theta U_k)$
Fundamental wave apparent power	$S_1 = U_1 \times I_1$
Fundamental wave reactive power	$Q_1 = (U_{1r} \times I_{1i} - U_{1i} \times I_{1r}) \times (-1)$
Fundamental wave power factor	$\lambda_1 =_{sic} \cos \varphi_1 $
<p>k: Analysis order; K: Maximum analysis order; r: Real part after FFT; i: Imaginary part after FFT; sic: Polarity symbol, assigned based on the fundamental wave reactive power Q_1 polarity Symbol [None]: Current lags voltage (LAG). Symbol [-]: Current leads voltage (LEAD).</p>	

Maintenance and Service

Chapter 6

Inspection and Repair

For more information about error messages, see 6.2 Error Indication (p.170).



WARNING Touching any of the high-voltage points inside the instrument is very dangerous. Customers are not allowed to modify, disassemble, or repair the instrument. Doing so may cause fire, electric shock, or injury.

- If damage is suspected, check the "Before having the instrument repaired" (p.168) section before contacting your authorized Hioki distributor or reseller.
- The fuse is housed in the power unit of the instrument. If the power does not turn on, the fuse may be blown. If this occurs, a replacement or repair cannot be performed by customers. Please contact your authorized Hioki distributor or reseller.

Calibrations

IMPORTANT

Periodic calibration is necessary in order to ensure that the instrument provides correct measurement results of the specified accuracy.

The calibration frequency varies depending on the status of the instrument or installation environment. We recommend that the calibration frequency is determined in accordance with the status of the instrument or installation environment and that you request that calibration be performed periodically.

Replaceable Parts and Operating Lifetimes

Properties of some parts used in the instrument may deteriorate after a long-term use.

The regular replacement of those parts is recommended to use the instrument properly for a long time.

For the replacement of the parts, please contact your authorized Hioki distributor or reseller.

The useful lives of the parts depend on the operating environment and frequency of use.

Operation cannot necessarily be guaranteed for the following recommended replacement period of each part.

Parts Name	Recommended Replacement Period	Note and Condition
Switching power supply	Approx. 6 years	After continuous use at 40°C The switching power supply will need to be replaced.

Precautions during shipment

Be sure to observe the following precautions:

- To avoid damage to the instrument, remove the accessories and optional equipment from the instrument. Moreover, use the original packing materials in which it was shipped, and be sure to pack in a double carton. Damage occurring during transportation is not covered by the warranty.
- When sending the instrument for repair, be sure to include details of the problem.

Cleaning

To clean the instrument, wipe it gently with a soft cloth moistened with water or mild detergent.

IMPORTANT

Never use solvents such as benzene, alcohol, acetone, ether, ketones, thinners or gasoline, as they can deform and discolor the case.

Disposing of the instrument

Handle and dispose of the instrument in accordance with local regulations.

6.1 Troubleshooting

Before having the instrument repaired

Symptom	Check Item, or Cause	Remedy and Reference
The display does not appear when you turn the power on.	Has the power cord been disconnected from the instrument? Is it connected properly?	Verify that the power cord is connected properly. See: 2.3 Connecting the Power Cord (p.33)
Keys do not work.	Has the key lock been activated?	Cancel the key lock state. See: 3.9.3 Disabling Control Keys (Key Lock) (p.109)
	Is the REMOTE lamp lit up?	The instrument is being controlled by the controller. End control and cancel the remote state. See: 4.3 Canceling the Remote State (Activating the Local State) (p.137)
Display values differ from those obtained from other instruments.	The instrument's apparent power (S), reactive power (Q), power factor (λ), and phase angle (φ) are calculated based on the measured voltage (U), current (I), and active power (P). Values displayed by the instrument may differ from values displayed by measuring instruments that use different operating principles or equations.	See: 5.5 Calculation Formulas Specifications (p.163)
The display value is zero.	Voltage values that are <u>less than $\pm 0.5\%$ of the measurement range</u> and current <u>values that are less than $\pm 0.5\%$ of the measurement range or less than $\pm 9 \mu\text{A}$</u> will be forcibly displayed as zero. (this is known as zero-suppression).	Lower the range. If the display value remains zero after lowering the range, the value may have exceeded the instrument's effective measurement range.
	Is the rectifier suitable for the measurement target? (If the DC rectifier is used with an AC signal, the display value will be zero.)	Set the rectifier properly. See: "Selecting the rectifier" (p.42)
I am unable to change the range.	Is range select off?	See: 3.2.3 Selecting the Voltage and Current Ranges (p.43)
	Has the key lock been activated?	See: 3.9.3 Disabling Control Keys (Key Lock) (p.109)
	Is the REMOTE lamp lit up?	See: 4.3 Canceling the Remote State (Activating the Local State) (p.137)
	Is the RUN lamp lit up?	See: 3.3 Integration (p.61)
	Is the HOLD lamp lit up?	See: 3.9.1 Fixing Display Values (Display Hold) (p.106)

If the HRM lamp (ERROR) lights up

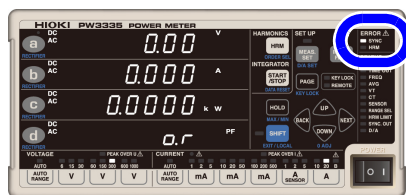

Accurate harmonic measurement cannot be performed while the **HRM** lamp (ERROR) is lit up.

- The **HRM** lamp (ERROR) will light up when the instrument receives input outside the synchronization frequency range for harmonic measurement or if it is unable to perform harmonic measurement due to the effects of noise. At that time, the instrument will show the invalid data display [- - - -].
- Since measurement processing will be reset when integration starts, preventing harmonic analysis from being performed properly during that interval, the **HRM** lamp (ERROR) will light up momentarily.

If the PEAK OVER U or PEAK OVER I lamp lights up

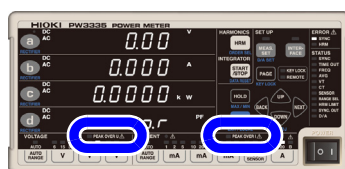

These lamps will light up if the voltage input or current input waveform peak value exceeds the figures listed below. At this time, the displayed data is not accurate.

- Voltage input waveform peak value: $\pm 600\%$ of the voltage range
When using the 300 V, 600 V, or 1,000 V range, $\pm 1,500$ V peak
- Current input waveform peak value: $\pm 600\%$ of the current range
When using the 20 A range, ± 100 A peak

Error display	Status	Solution
PEAK OVER U	When greater than $\pm 1,500$ V peak	Stop measurement immediately, deactivate power to measurement lines, and disconnect wires.
	When less than $\pm 1,500$ V peak	The internal circuit is not operating properly. Switch to a range for which the PEAK OVER U lamp does not light up. See: 3.2.3 Selecting the Voltage and Current Ranges (p.43)
PEAK OVER I	When greater than ± 60 A peak	Stop measurement immediately, deactivate power to measurement lines, and disconnect wires.
	When less than ± 60 A peak	The internal circuit is not operating properly. Switch to a range for which the PEAK OVER I lamp does not light up. See: 3.2.3 Selecting the Voltage and Current Ranges (p.43)

When no apparent cause can be established

Perform a system reset.

This will return all settings to their factory defaults.

See: 3.9.4 Initializing the Instrument (System Reset) (p.110)

6.2 Error Indication

The instrument will display an error if a malfunction is found during the self-test when the instrument is turned on or if it is unable to accept key input for some reason.









See: 3.9.4 Initializing the Instrument (System Reset) (p.110)



If the measurement lines are energized when the instrument is turned on, the instrument may be damaged or an error message may appear, so before energizing the lines, turn the instrument on and confirm that no error message is displayed.

Contact your authorized Hioki distributor or reseller if a repair should become necessary.

Error display	Description	Cause and Remedy
	ROM error	The instrument needs to be repaired. (Circuit failure)
	SDRAM error	
	Control circuit error	
	Buffer data error	Pressing any key will cause the instrument to switch to the measurement display after performing a system reset. If this error occurs frequently, the instrument will need to be repaired. The circuit used to save settings may be damaged.
	Invalid key input (displayed for approx. 1 sec.)	This error is displayed when key and external control are mixed during integration.
	Invalid key input (displayed for approx. 1 sec.)	This error is displayed when an invalid operation is attempted during integration. Example: Range switching This error is displayed when the user attempts to perform zero adjustment while the CURRENT lamp is flashing and integration is stopped.
	Invalid key input (displayed for approx. 1 sec.)	This error is displayed when the user attempts to start integration after the integration limit (integration time, integrated value) has been reached. This error is displayed when the user attempts to start integration while the CURRENT lamp is flashing.
	Invalid key input (displayed for approx. 1 sec.)	This error is displayed when a data reset is performed during integration.
	Invalid key input (displayed for approx. 1 sec.)	This error is displayed when an invalid operation is performed during display hold operation.
	Invalid key input (displayed for approx. 1 sec.)	This error is displayed when a range key that has been disabled with the range select function is pressed.
	Zero-adjustment failure (displayed for approx. 1 sec.)	This error is displayed when input exceeds the zero-adjustment range. See: 2.5 Performing Zero-adjustment (p.35)

Error display	Description	Cause and Remedy
	Synchronization loss	This error is displayed when no external signal is received while the instrument has been set as the slave with the external synchronization function. See: 3.5 Performing Synchronized Measurement with Multiple Instruments (Multiple-instrument Synchronized Measurement) (p.78)
	Over-range	This error is displayed when the voltage or current exceeds 152% of the range (or 1,060.5 V when using the 1,000 V voltage range). See: 3.10.3 When o.r (over-range) Is Displayed (p.113) 3.2.3 Selecting the Voltage and Current Ranges (p.43)
	Scaling error	This error is displayed when the display range has been exceeded due to the VT ratio or CT ratio setting. Change the VT or CT ratio. See: 3.2.8 Setting the VT Ratio and CT Ratio (p.58)
 	External current sensor input	This error is displayed when a range key other than 1 A to 5 A is pressed while using external current sensor input. See: 3.8 Using a Current Sensor (p.100)
	No measurement or measured value not ready	When starting averaging, the [- - - -] display will change to the measured value display when the first average value has been calculated.
	Success initializing Bluetooth® serial conversion adapter	The Bluetooth® serial conversion adapter was successfully initialized.
	Failure initializing the Bluetooth® serial conversion adapter	Turn on the adapter. Verify that the adapter's communication speed matches the instrument's setting.

Appendix

Appendix 1 Detailed Specifications of Measurement Items (Display Items)

Measured value display (if using communications, measured value data) ●: Displayed –: Not displayed

Measurement items			Rectifier					Display range
			AC+DC	AC+DC Umn	DC	AC	FND	
Voltage	V		●	●	●	●	●	Up to ±152% of range. However, zero-suppression when less than ±0.5%
Current	A		●	●	●	●	●	Up to ±152% of range. However, zero-suppression when less than ±0.5% or less than ±9 μA.
Active power	W		●	●	●	●	●	±0% to ±231.04% of range
Apparent power	VA		●	●	–	●	●	0% to 231.04% of range
Reactive power	var		●	●	–	●	●	±0% to ±231.04% of range
Power factor	PF		●	●	–	●	●	±0.0000 to ±1.0000
Phase angle	°		–	–	–	●	●	+180.00 to -180.00
Frequency	Voltage	VHz	–	–	–	–	–	0.1000 to 100.00 kHz
	Current	AHz	–	–	–	–	–	
Current integration	Positive	Ah+	–	–	●	–	–	Display resolution 999999
	Negative	Ah-	–	–	●	–	–	
	Total	Ah	●*	●*	●	–	–	
Active power integration	Positive	Wh+	●	●	●	–	–	Display resolution 999999
	Negative	Wh-	●	●	●	–	–	
	Total	Wh	●	●	●	–	–	
Integration time	TIME		–	–	–	–	–	00.00.00 to 10000.0
Waveform peak value	Voltage	Vpk	–	–	–	–	–	Up to ±102% of peak range
	Current	Apk	–	–	–	–	–	
Crest factor	Voltage	CF V	–	–	–	–	–	1.0000 to 612.00
	Current	CF A	–	–	–	–	–	
Maximum current ratio	MCR		–	–	–	–	–	1.0000 to 6.1200 M
Time average current	T.AV A		●*	●*	●	–	–	±0% to ±612% of range
Time average active power	T.AV W		●	●	●	–	–	±0% to ±3745.4% of range
Ripple rate	Voltage	RF V%	–	–	–	–	–	0.00% to 500.00%
	Current	RF A%	–	–	–	–	–	
Total harmonic distortion	Voltage	THD V%	–	–	–	–	–	0.00% to 500.00%
	Current	THD A%	–	–	–	–	–	

* During auto-range integration mode operation, this data is invalid (–: None).

Appendix 2 Detailed Specifications of Output

Appendix 2.1 Detailed Specifications of Level Output

PW3335-02 | PW3335-04

●: Installed – : Not installed Lo.: 0 V output

Measurement items		Rectifier					Rated output voltage
		AC+DC	AC+DC +Umn	DC	AC	FND	
Voltage	V	●	●	●	●	●	Relative to ±100% of the range STD.2: ±2 V DC STD.5: ±5 V DC
Current	A	●	●	●	●	●	
Active power	W	●	●	●	●	●	
Apparent power	VA	●	●	Lo.	●	●	
Reactive power	var	●	●	Lo.	●	●	
Power factor	PF	●	●	Lo.	●	●	STD.2: ±2 V DC at ±0.0000, ±0 V DC at ±1.0000 STD.5: ±5 V DC at ±0.0000, ±0 V DC at ±1.0000
Phase angle	°	Lo.	Lo.	Lo.	●	●	STD.2: ±0 V DC at 0.00°, ±2 V DC at ±180.00° STD.5: ±0 V DC at 0.00°, ±5 V DC at ±180.00°
Frequency	VHz AHz	–	–	–	–	–	5 V at set value Example: If set to 5 kHz, 5 V DC at 5 kHz
Time average current	T.AV A	●*	●*	●	Lo.	Lo.	Relative to ±100% of the range STD.2: ±2 V DC STD.5: ±5 V DC
Time average active power	T.AV W	●	●	●	Lo.	Lo.	
Current integration	Ah+ Ah-	Lo.	Lo.	●	Lo.	Lo.	5 V when set value is reached Example: If set to 5 kAh, 5 V DC at 5 kAh
	Ah	●*	●*	●	Lo.	Lo.	
Active power integration	Wh+ Wh- Wh	●	●	●	Lo.	Lo.	5 V when set value is reached Example: If set to 5 kWh, 5 V DC at 5 kWh
Crest factor	CF V CF A	–	–	–	–	–	STD.2: ±2 V DC at 10.000 STD.5: ±5 V DC at 10.000
Ripple rate	RF V% RF A%	–	–	–	–	–	STD.2: ±2 V DC at 100.00% STD.5: ±5 V DC at 100.00%
Total harmonic distortion	THD V% THD A%	–	–	–	–	–	
Maximum current ratio	MCR	–	–	–	–	–	STD.2: ±2 V DC at 10.000 STD.5: ±5 V DC at 10.000

* During auto-range integration mode operation, the display will indicate Lo. (0 V output).

Appendix 2.2 Detailed Specifications of High-speed Level Output

PW3335-02 | PW3335-04

●: Installed – : Not installed

Measurement items		Rectifier					Rated output voltage
		AC+DC	AC+DC +Umn	DC	AC	FND	
Voltage	V	●	–	–	–	–	Relative to $\pm 100\%$ of the range FASt.2: ± 2 V DC FASt.5: ± 5 V DC
Current	A	●	–	–	–	–	
Active power	W	●	–	–	–	–	

Appendix 2.3 Detailed Specifications of Waveform Output

PW3335-02 | PW3335-04

●: Installed – : Not installed

Measurement items		Rectifier					Rated output voltage
		AC+DC	AC+DC +Umn	DC	AC	FND	
Instantaneous voltage	V	●	–	–	–	–	FASt 1 Vf.s. relative to $\pm 100\%$ of the range (RMS level)
Instantaneous current	A	●	–	–	–	–	
Instantaneous power	W	●	–	–	–	–	

Appendix 3 Example Accuracy Calculations

Basic approach to accuracy

When the accuracy notation combines rdg. and f.s.

Accuracy specification: $\pm 0.2\%$ rdg. $\pm 0.1\%$ f.s.

Measurement range: 300.00 V

Measured value: 100.00 V

Since the value being measured is 100.00 V;

(A) Reading error ($\pm\%$ rdg.): $\pm 0.2\%$ of 100.00 V = ± 0.20 V

(B) Full-scale error ($\pm\%$ f.s.): $\pm 0.1\%$ of 300 V = ± 0.30 V

(C) Total error (A+B): ± 0.50 V

Based on the total error (C), the error boundary values for a measured value of 100.00 V would be 99.50 V to 100.50 V.

Method for calculating accuracy when using a current sensor

Power measurement error = Instrument's measurement error + 9661 Current Sensor additional error

Example calculation: If input is less than 50% of the range

Measurement conditions

Voltage range of 300 V, current range of 200 A (2 A range, CT ratio: 100), power display value of 16 kW

Voltage input of 200 V, current input of 80 A, 50 Hz, sine wave

- Effective power accuracy of instrument's external current sensor input: $\pm 0.1\%$ rdg. $\pm 0.1\%$ f.s.
(Representative accuracy when input is less than 50% of the range)
- 9661 measurement accuracy: $\pm 0.3\%$ rdg. $\pm 0.01\%$ f.s.

Calculation method

1. Check the instrument's power range in the instruction manual.
Voltage range: 300 V, Current range: 200 A (2 A range, CT ratio: 100) → 60.000 kW range
2. Calculate the instrument's error.
 $\pm(16 \text{ kW} \times 0.1\%) \text{ rdg.} \pm(60 \text{ kW} \times 0.1\%) \text{ f.s.} = \underline{\pm 0.076 \text{ kW}}$
3. Check the power range to use when calculating the 9661's accuracy addition.
Since the sensor is the 9661, use the power range for the 500 A current range (5 A range, CT ratio: 100) for f.s.*
Voltage range: 300 V, Current range: 500 A (5 A range, CT ratio: 100) → 150 kW range
4. Calculate the additional power accuracy when using the 9661.
 $\pm(16 \text{ kW} \times 0.3\%) \text{ rdg.} \pm(150 \text{ kW} \times 0.01\%) \text{ f.s.} = \underline{\pm 0.063 \text{ kW}}$
5. Add the instrument's error and the 9661 error.
 $\pm 0.076 \text{ kW} \pm 0.063 \text{ kW} = \pm 0.139 \text{ kW} \dots \pm 0.87\% \text{ rdg.}$

* Since the current sensor itself has no power range, use the power meter's power range when calculating the f.s. error.

Appendix 4 Rack Mounting

By removing the screws on the sides, this instrument can be installed in a rack mounting plate.



Observe the following precautions regarding the mounting screws to avoid instrument damage and electric shock accidents.

- When installing the Rack Mounting Plate, the screws must not intrude more than 6 mm into either side of the instrument.
- When removing the Rack Mounting Plate to return the instrument to stand-alone use, replace the same screws that were installed originally. (Feet: M3 × 6 mm, Sides: M4 × 6 mm)

When installing into the rack, reinforce the installation with a commercially available support stand.

Rack mounting plate template diagram

(Unit: mm)

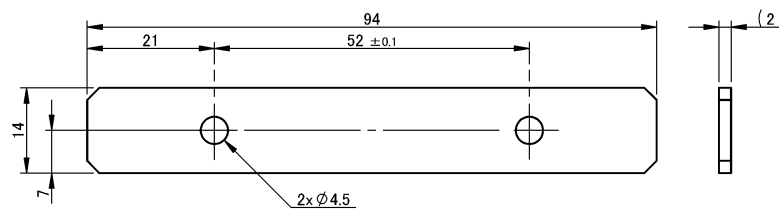

Spacer (same hardware for EIA/JIS)

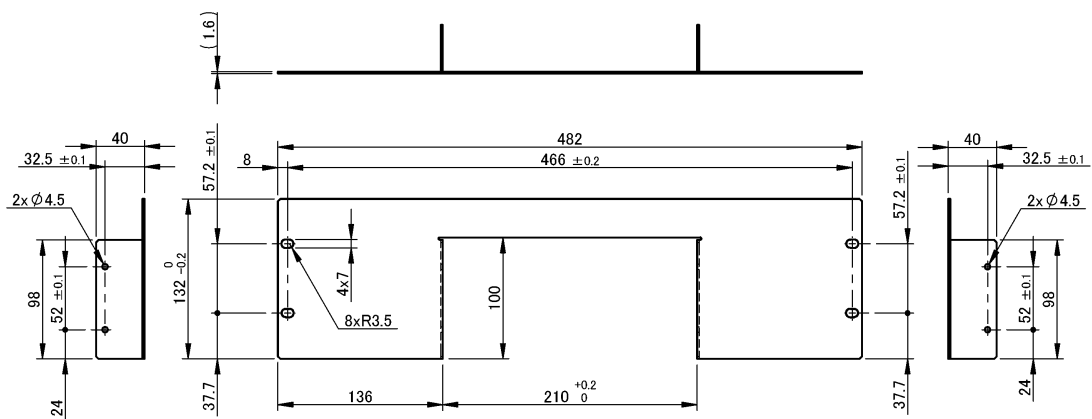

Rack mounting plate (EIA, for mounting 1 instrument)

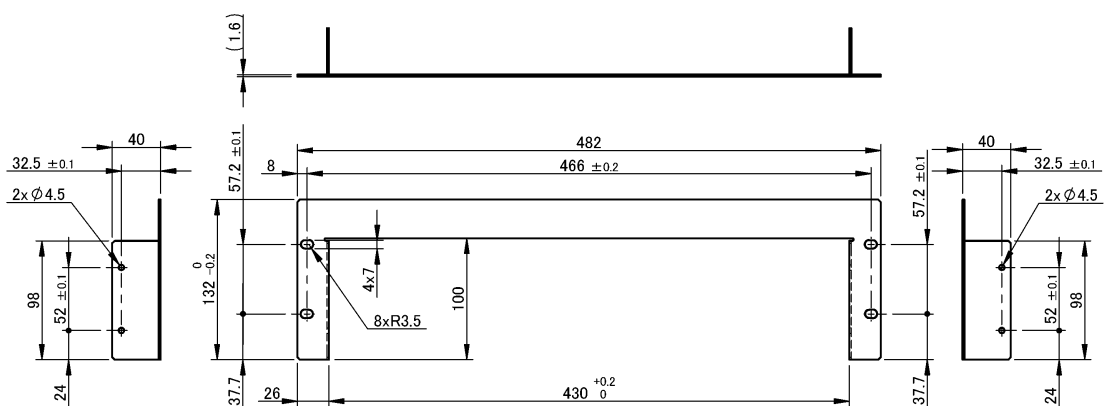

Rack mounting plate (EIA, for mounting 2 instruments)

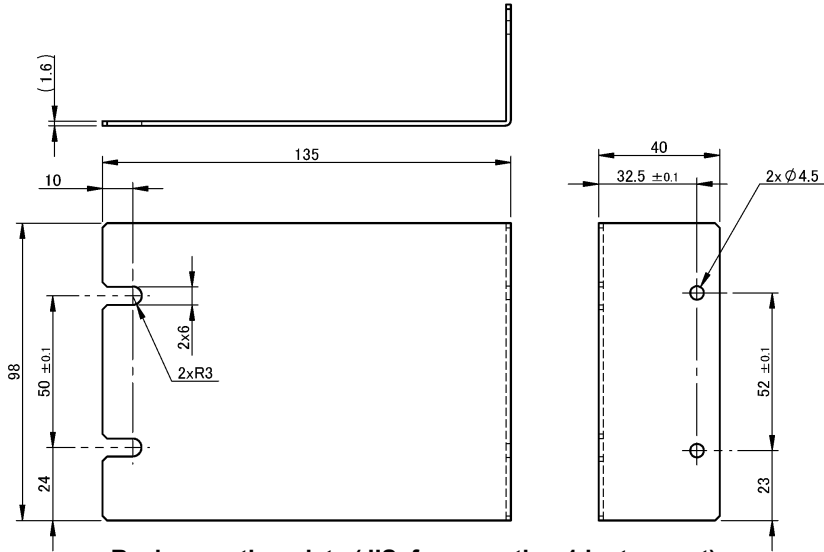

Rack mounting plate (JIS, for mounting 1 instrument)

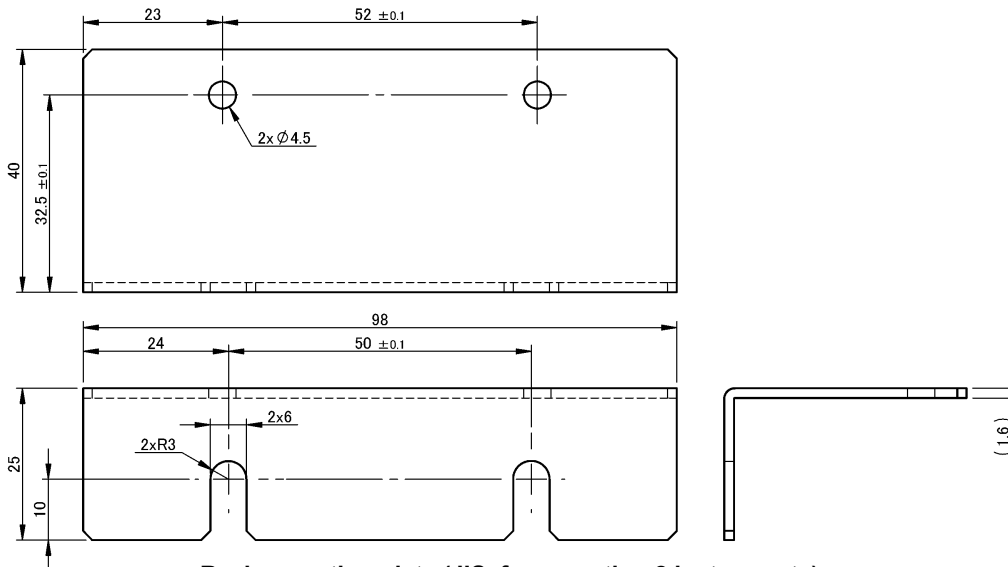

Rack mounting plate (JIS, for mounting 2 instruments)

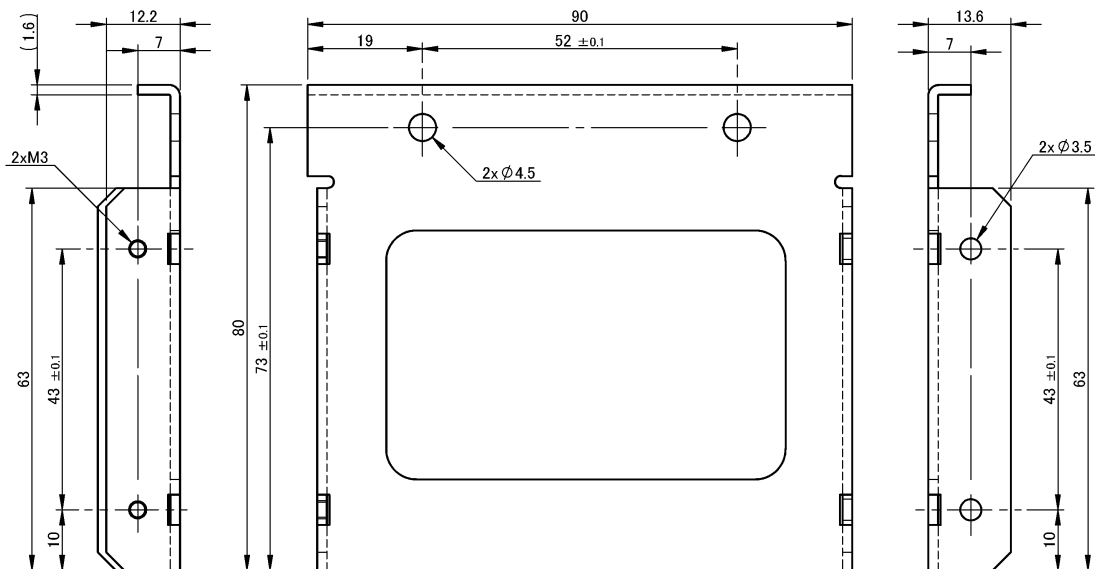

Rack mounting plate (same hardware for EIA/JIS, for mounting 2 instruments)

Installation procedure

- 1 Remove the feet from the bottom of the instrument, and the screws from the sides (four near the front).

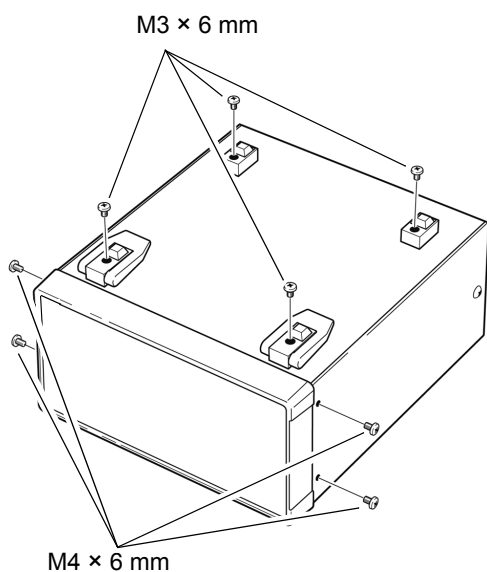

- 2 1 instrument

Installing the spacers on both sides of the instrument, affix the rack mounting plate (for mounting 1 instrument) with the M4 × 10 mm screws (4 locations).

EIA

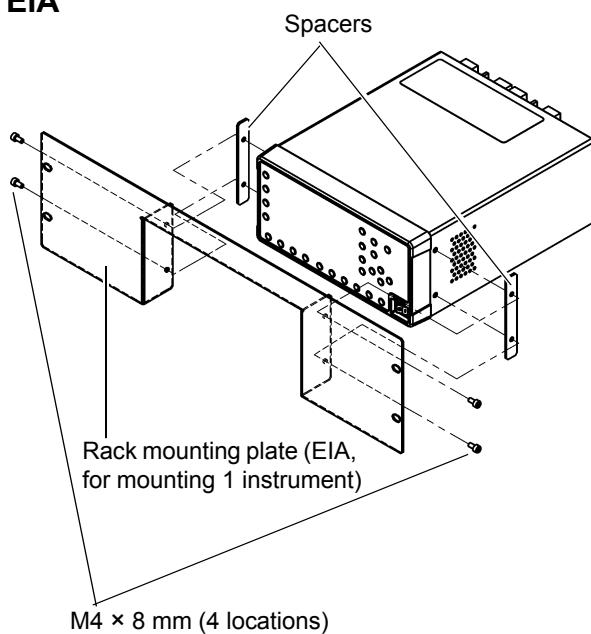

JIS

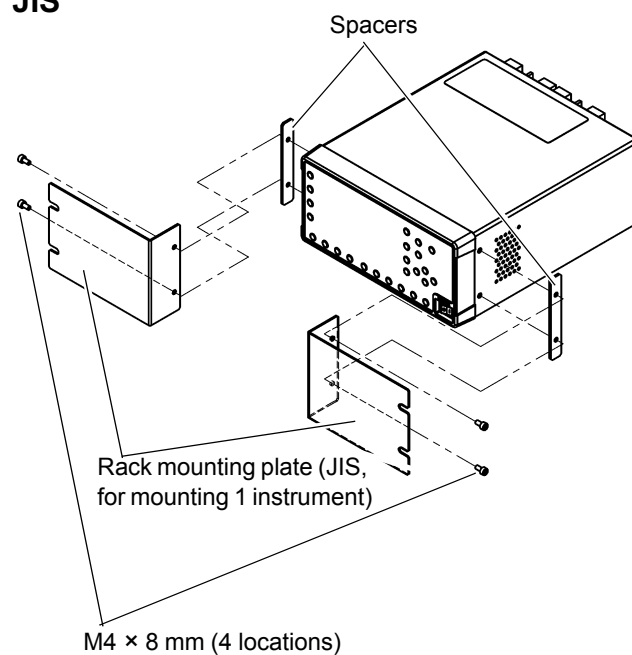

2 2 instrument

- 1.** Attach rack mounting plates (same hardware for EIA/JIS, for mounting 2 instruments) to the inside sides of the two instruments that are to be connected together using M4 × 8 mm screws (4 locations).
- 2.** Connect the rack mounting plates attached in step (1) above using M3 × 6 mm screws (4 locations).
- 3.** Insert spacers on the outside sides of the two connected instruments and attach them to the rack mounting plate (for mounting 2 instruments) with M4 × 8 mm screws (4 locations).

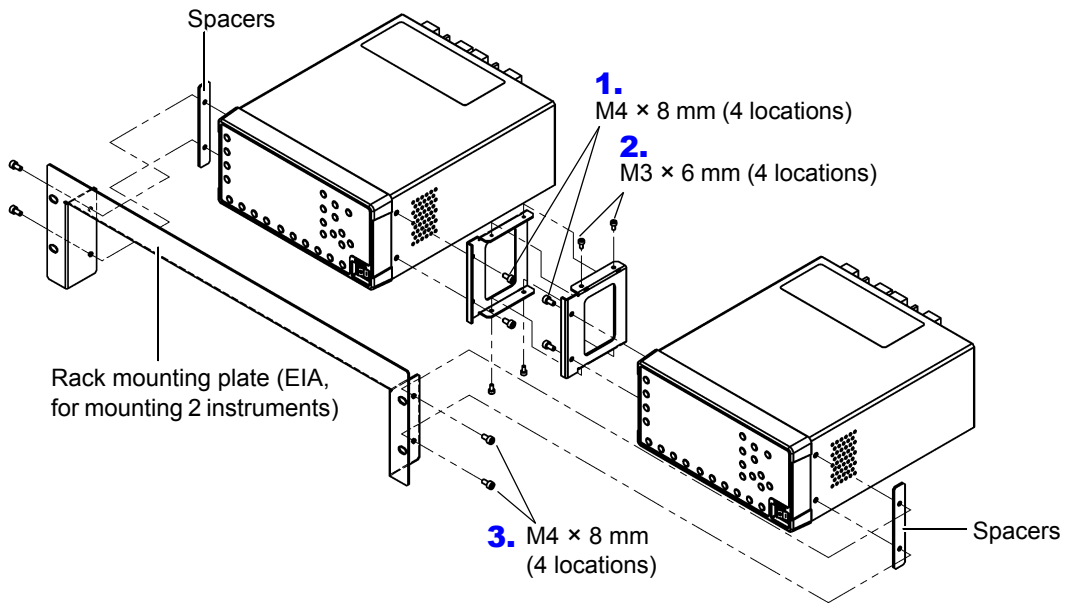
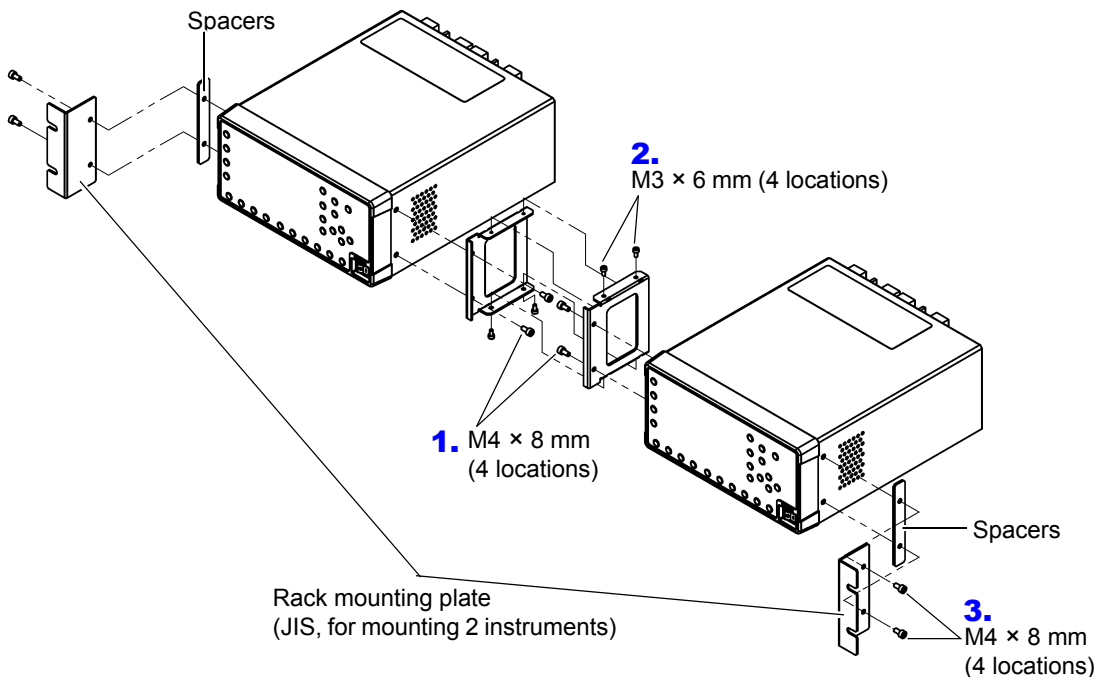
EIA**JIS**

Appendix 5 Dimensional Diagram

Example: PW3335-04

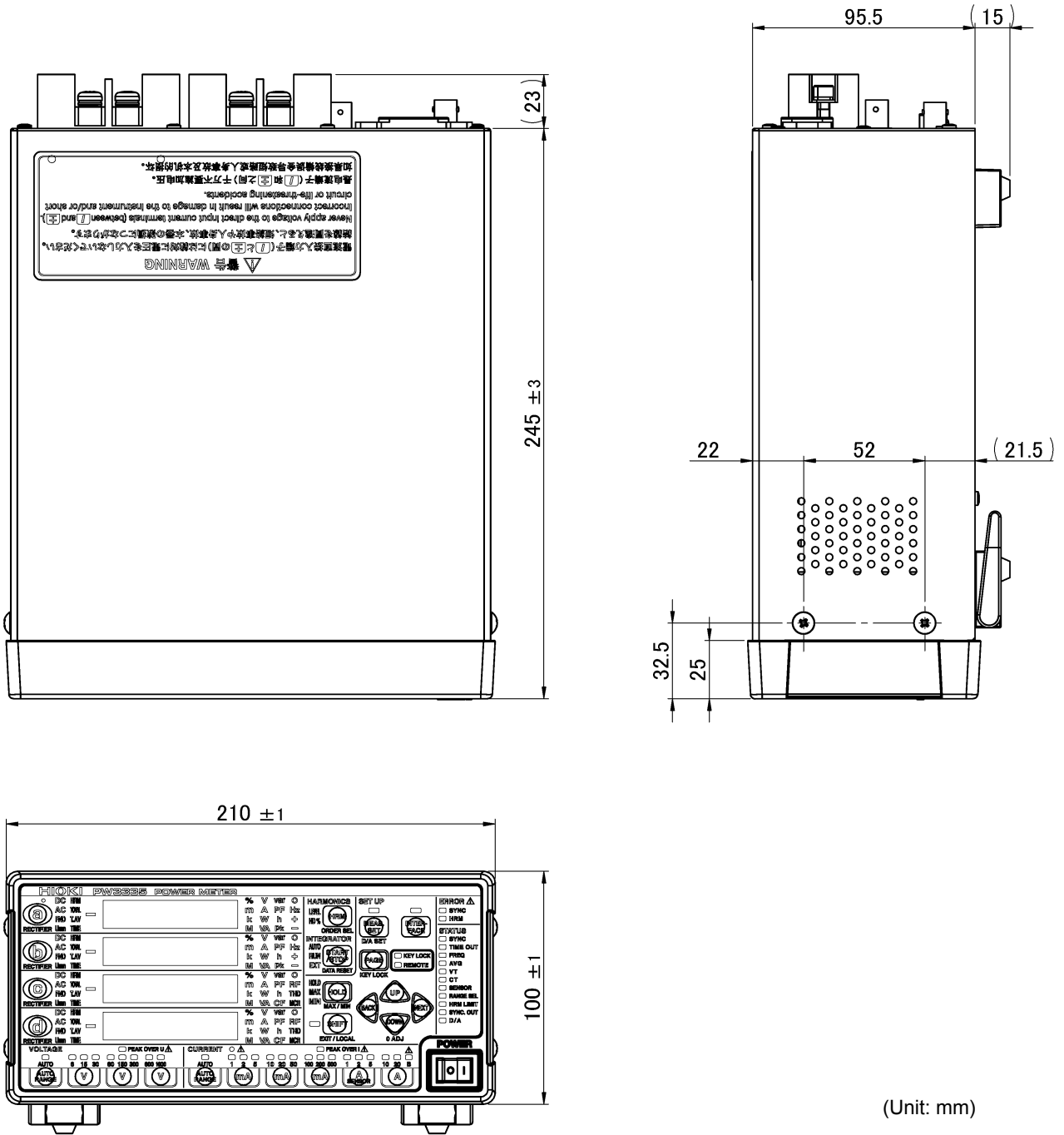

Appendix 6 Terminology

Terminology	Description
Crest factor	<p>Crest factor, which is the ratio of the crest value (peak value) to the RMS value of the voltage waveform or current waveform, and can be defined with the following expression. Crest factor = crest value (peak value)/RMS value</p> <p>For a pure sine wave, the crest factor is 1.4142... ($\sqrt{2}$). For pure DC current, it is 1. For measuring instruments such as power meters, the crest factor may also indicate the magnitude of the internal circuitry's dynamic range.</p>
Effect of power factor	Error caused by the phase difference between voltage and current in the instrument's internal circuitry. The effect of power factor affects active power measured values.
Harmonics HRM	A phenomenon caused by distortions in the voltage and current waveforms that affect many devices with power supplies using semiconductor control devices. In the analysis of non-sine waves, the term refers to one RMS value among the components with harmonic frequencies.
IEC61010	The International Electrotechnical Commission (IEC) has established IEC 61010 as a safety standard for measuring instruments. To ensure that measuring instruments can be used safely, this standard defines safety levels as a series of measurement categories (CAT II to CAT IV) based on the locations in which instruments are used. (p.4)
Instrument loss	Instrument loss, which is caused by the input resistance of power measuring instruments' voltage and current inputs, increases with the input voltage and input current as well as with certain connection methods, and this in turn causes the error component of measured values to increase.

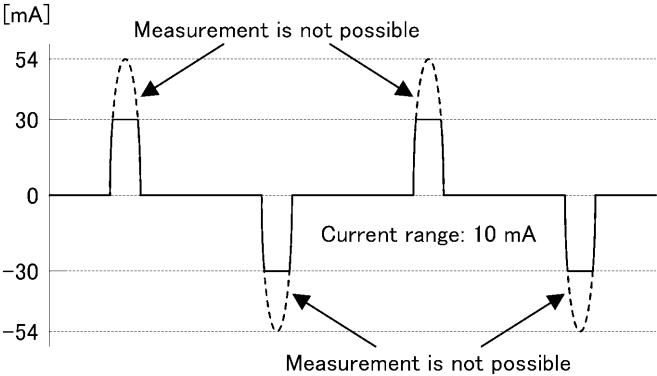
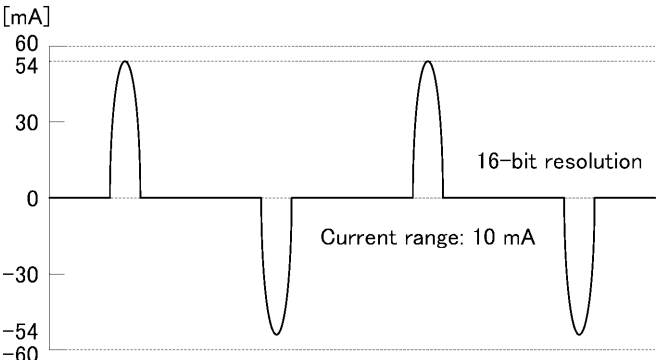
Terminology	Description
<p>Maximum effective peak voltage Maximum effective peak current</p>	<p>The maximum effective peak voltage (current) refers to the maximum peak value (crest value) for the input waveform that can be processed as a valid measured value by the instrument. This value indicates the internal circuitry's dynamic range. For some measuring instruments, this value may also be called the crest factor. (Since the PW3335's maximum effective peak voltage and maximum effective peak current are $\pm 600\%$ of each range, the crest factor is 6. However, the value is $\pm 1,500$ V peak for the 300 V, 600 V, and 1,000 V ranges and ± 60 A peak for the 20 A range.)</p> <p>When using an instrument whose internal circuitry has a narrow dynamic range to measure a distorted wave with a small RMS value but a large peak value, the distorted wave's peak may become saturated (clipped), preventing accurate measurement.</p> <p>The following figure illustrates an example in which an input current waveform with a crest factor of 5.4 (RMS value of 10 mA and peak value of ± 54 mA) is measured using the 10 mA range.</p>  <p>Example using an instrument with a narrow dynamic range (crest factor of 3)</p> <p>Since the dynamic range for the 10 mA range, with which an RMS value of 10 mA can be measured with the greatest accuracy, is ± 30 mA, portions of the waveform exceeding this level will be clipped, preventing accurate measurement. While exceeding the internal circuitry's dynamic range can be avoided by increasing the measurement range, this has the effect of lowering the measurement resolution and increasing measurement error.</p>  <p>PW3335 (crest factor of 6)</p> <p>Since the PW3335 has a dynamic range of ± 60 mA for the 10 mA range, the 10 mA range, which is the optimal range, can be used.</p> <p>In addition, the peak-over lamps (PEAK OVER U and PEAK OVER I) will light up if input exceeding this dynamic range is received in order to notify the user that the data is invalid.</p>
<p>MCR</p>	<p>A value used to determine the maximum permitted uncertainty in power measurement as defined by "IEC 62301:2011 Household electrical appliances – Measurement of standby power." Under the standard, MCR is calculated using the following formula: Maximum current ratio (MCR) = Crest factor (CF) / Power factor (PF)</p>

Terminology	Description
RECTIFIER	For the PW3335, the rectifier refers to the rectification method. (p.42)
AC + DC	Displays true RMS values for DC only, AC only, or mixed DC and AC voltage and current. True RMS: The waveform including harmonic components is determined based on the RMS calculation formula.
AC + DC Umn	Umn: Abbreviation for "voltage mean." Displays mean value rectified RMS equivalents for DC only, AC only, or mixed DC and AC voltage. Current values are displayed as RMS values. Mean value rectified RMS equivalents: The input waveform is treated as an undistorted sine wave (single frequency only). The AC signal mean is calculated, converted to an RMS value, and displayed. The measurement error increases when the waveform is distorted.
FND	FND: Abbreviation for "fundamental." Extracts and displays the fundamental wave component only using harmonic measurement.
Ripple rate	The ratio of the AC component contained in a DC voltage or DC current to the DC component.
Total harmonic voltage distortion Total harmonic current distortion (THD)	THD: Abbreviation for "total harmonic distortion." There are two types of THD: THD-F: The ratio of the size of the total harmonic component to the size of the fundamental wave, expressed as a percentage using the following equation: $\frac{\sqrt{\sum (\text{from 2nd order})^2}}{\text{fundamental wave}} \times 100[\%]$ (for the PW3335, calculation of up to the 50th order depending on the input frequency) This value can be monitored to assess waveform distortion for each item, providing a yardstick that indicates the extent to which the total harmonic component is distorting the fundamental waveform. THD-R: The ratio of the size of the total harmonic component to the size of RMS values, expressed as a percentage using the following equation: $\frac{\sqrt{\sum (\text{from 2nd order})^2}}{\text{RMS value}} \times 100[\%]$ (for the PW3335, calculation of up to the 50th order depending on the input frequency) THD-F is typically used. The PW3335 displays THD-F as THD. (THD-R is not available as a measurement parameter.)
Zero-cross filter	The PW3335 calculates parameters such as RMS values and active power based on one cycle of the synchronization source's input waveform (voltage U or current I). This cycle is obtained by detecting the zero-cross interval (the interval from one rising edge until the next cycle's rising edge). A filter used when it is not possible to accurately detect the zero-cross due to the effects of ringing or noise close to the input waveform's zero-cross point.
Zero-suppression	Functionality for treating values that are less than a certain threshold as zero.

Index

A

AC	42
AC+DC	42, A 12
AC+DC Umn	42, A 12
Accuracy calculations	A 4
Additional integration	64
Auto-range	44
Averaging	56
AVG	56

B

Backup function	34
Browser	134

C

Cleaning	168
Communications	
1:1	126
Default Gateway	120
IP address	120
Subnet mask	120
Connection method selection	30
Crest factor	A 10
CT	26, 32
CT ratio	58
Current direct input	38
Current ranges	43
Current sensor	100

D

Damage	167
DATA RESET	65
DC	42
Dedicated application	119
Dimensional diagram	A 9
Display hold	106
Display parameters	40, A 1
Disposing	168

E

Effect of power factor	A 10
Error Indication	170
EXT.CONTROL	82
External control	62, 82

External CT	105
External current sensor input	38

F

FND	42, A 12
FREQ	50
Frequency measurement range	50

G

GP-IB	131
GP-IB address	133
GP-IB connector	18, 132

H

Harmonic	71, A 10
Harmonic analysis order	76
High-speed level output	88
HOLD	106
HRM	A 10
HRM ERROR	77

I

IEC61010	A 10
Instantaneous value	107
Instrument loss	A 10
Instrument loss calculation	30
Integrated value display format	70
Integration	61
Integration time	65

K

KEY LOCK	109
----------------	-----

L

LAN	120
Level output	88
Local	137

M

MAC address	124
Master	78
MAX/MIN	107
Maximum effective peak current	A 11

Index 2

Maximum effective peak voltage	A 11
Maximum value	107
MCR	A 11
Measurement items	A 1
Measurement workflow	20
Minimum value	107

N

Number of averaging	56
---------------------------	----

O

o.r	113
ORDER SEL	72

P

Power	33, 34
Power cord	33

Q

Query error	131
-------------------	-----

R

Rack mounting	A 5
Range select function	46
RECTIFIER	A 12
Rectifier	42
Remote	137
Repair	167
Replaceable parts	167
Resetting integrated values	65
Ripple rate	A 12
RS-232C	127
RS-232C connector	18, 129

S

Slave	78
Solderless terminals	27
Subnet mask	120
SYNC	48
SYNC (ERROR)	50
Synchronization source	48
Synchronized measurement	78
System reset	110

T

THD	A 12
Time average active power	62
Time average current	62
Timeout (TIME OUT)	54
Timer integration	65

Total harmonic current distortion	A 12
Total harmonic voltage distortion	A 12
TYPE.1 current sensors	38
TYPE.2 current sensors	38

U

Unit indicator flashes	114
------------------------------	-----

V

Voltage ranges	43
VT (PT)	26, 32
VT ratio	58

W

Waveform output	88
-----------------------	----

Z

Zero-adjustment	35
Zero-cross filter	50, A 12
Zero-suppression	23, 40, 45, 168, A 12

Warranty Certificate

HIOKI

Model	Serial number	Warranty period Three (3) years from date of purchase (___ / ___)
-------	---------------	--

Customer name: _____

Customer address: _____

Important

- Please retain this warranty certificate. Duplicates cannot be reissued.
- Complete the certificate with the model number, serial number, and date of purchase, along with your name and address. The personal information you provide on this form will only be used to provide repair service and information about Hioki products and services.

This document certifies that the product has been inspected and verified to conform to Hioki's standards. Please contact the place of purchase in the event of a malfunction and provide this document, in which case Hioki will repair or replace the product subject to the warranty terms described below.

Warranty terms

1. The product is guaranteed to operate properly during the warranty period (three [3] years from the date of purchase). If the date of purchase is unknown, the warranty period is defined as three (3) years from the date (month and year) of manufacture (as indicated by the first four digits of the serial number in YYMM format).
2. If the product came with an AC adapter, the adapter is warranted for one (1) year from the date of purchase.
3. The accuracy of measured values and other data generated by the product is guaranteed as described in the product specifications.
4. In the event that the product or AC adapter malfunctions during its respective warranty period due to a defect of workmanship or materials, Hioki will repair or replace the product or AC adapter free of charge.
5. The following malfunctions and issues are not covered by the warranty and as such are not subject to free repair or replacement:
 - 1. Malfunctions or damage of consumables, parts with a defined service life, etc.
 - 2. Malfunctions or damage of connectors, cables, etc.
 - 3. Malfunctions or damage caused by shipment, dropping, relocation, etc., after purchase of the product
 - 4. Malfunctions or damage caused by inappropriate handling that violates information found in the instruction manual or on precautionary labeling on the product itself
 - 5. Malfunctions or damage caused by a failure to perform maintenance or inspections as required by law or recommended in the instruction manual
 - 6. Malfunctions or damage caused by fire, storms or flooding, earthquakes, lightning, power anomalies (involving voltage, frequency, etc.), war or unrest, contamination with radiation, or other acts of God
 - 7. Damage that is limited to the product's appearance (cosmetic blemishes, deformation of enclosure shape, fading of color, etc.)
 - 8. Other malfunctions or damage for which Hioki is not responsible
6. The warranty will be considered invalidated in the following circumstances, in which case Hioki will be unable to perform service such as repair or calibration:
 - 1. If the product has been repaired or modified by a company, entity, or individual other than Hioki
 - 2. If the product has been embedded in another piece of equipment for use in a special application (aerospace, nuclear power, medical use, vehicle control, etc.) without Hioki's having received prior notice
7. If you experience a loss caused by use of the product and Hioki determines that it is responsible for the underlying issue, Hioki will provide compensation in an amount not to exceed the purchase price, with the following exceptions:
 - 1. Secondary damage arising from damage to a measured device or component that was caused by use of the product
 - 2. Damage arising from measurement results provided by the product
 - 3. Damage to a device other than the product that was sustained when connecting the device to the product (including via network connections)
8. Hioki reserves the right to decline to perform repair, calibration, or other service for products for which a certain amount of time has passed since their manufacture, products whose parts have been discontinued, and products that cannot be repaired due to unforeseen circumstances.

HIOKI E.E. CORPORATION

<http://www.hioki.com>

18-07 EN-3

HIOKI
www.hioki.com/



**All regional
contact
information**

HIOKI E.E. CORPORATION

81 Koizumi, Ueda, Nagano 386-1192 Japan

2309 EN

Edited and published by HIOKI E.E. CORPORATION

Printed in Japan

- Contents subject to change without notice.
- This document contains copyrighted content.
- It is prohibited to copy, reproduce, or modify the content of this document without permission.
- Company names, product names, etc. mentioned in this document are trademarks or registered trademarks of their respective companies.

Europe only

- EU declaration of conformity can be downloaded from our website.
- Contact in Europe: HIOKI EUROPE GmbH
Helfmann-Park 2, 65760 Eschborn, Germany hioki@hioki.eu